

Virgo_nEXT

Matteo Barsuglia

On behalf of the IN2P3 labs

CS IN2P3 - 3/7/2023

Outline

- The context : LIGO-Virgo-KAGRA detectors and results
- Virgo_nEXT: history and sensitivity
- Why Virgo_nEXT?
 - Science case
 - Virgo_nEXT as a testbench for ET
 - Bridging the gap between Advanced Virgo+ and ET and keeping the expertise

GW detectors and observing runs

Current infrastructures

New infrastructures

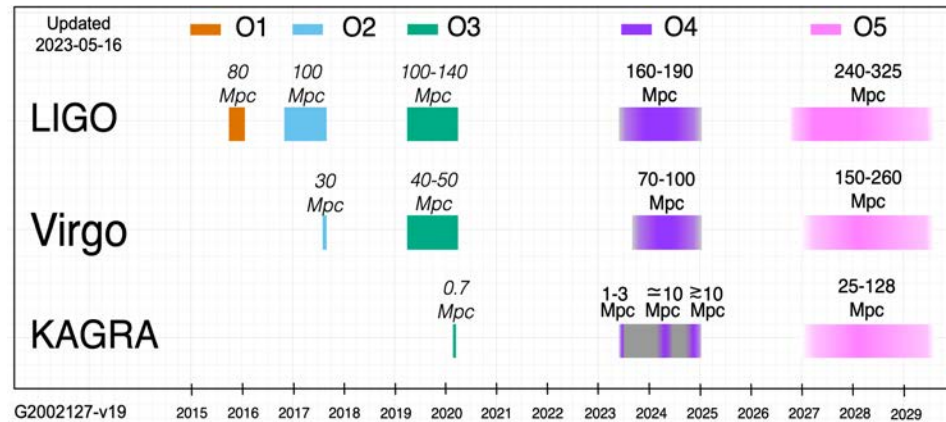

LIGO upgrade A#

Virgo_nEXT

KAGRA upgrade

Cosmic Explorer

Einstein Telescope

2030's

- First light before end of 2030' decade
- Full sensitivity a few years later (TBC)

First detection

90 sources

GW170817

GW detectors and observing runs

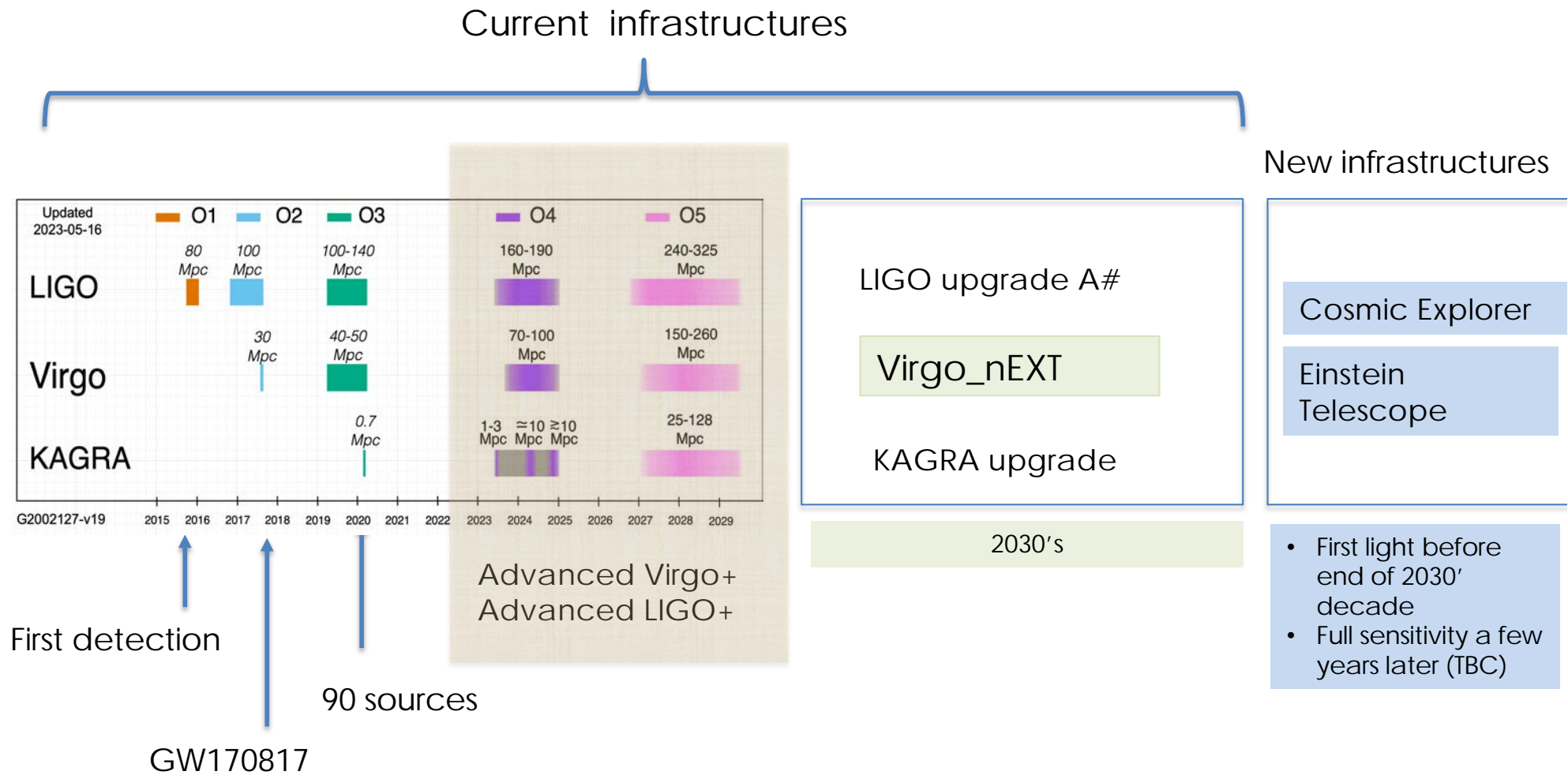

The current detectors and infrastructures



LIGO
Livingston

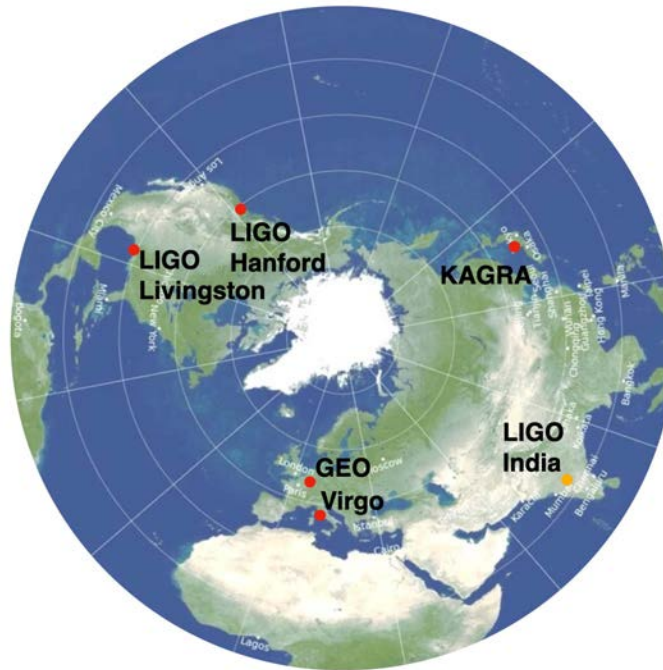

LIGO
Hanford

Virgo



KAGRA



GW detectors and observing runs

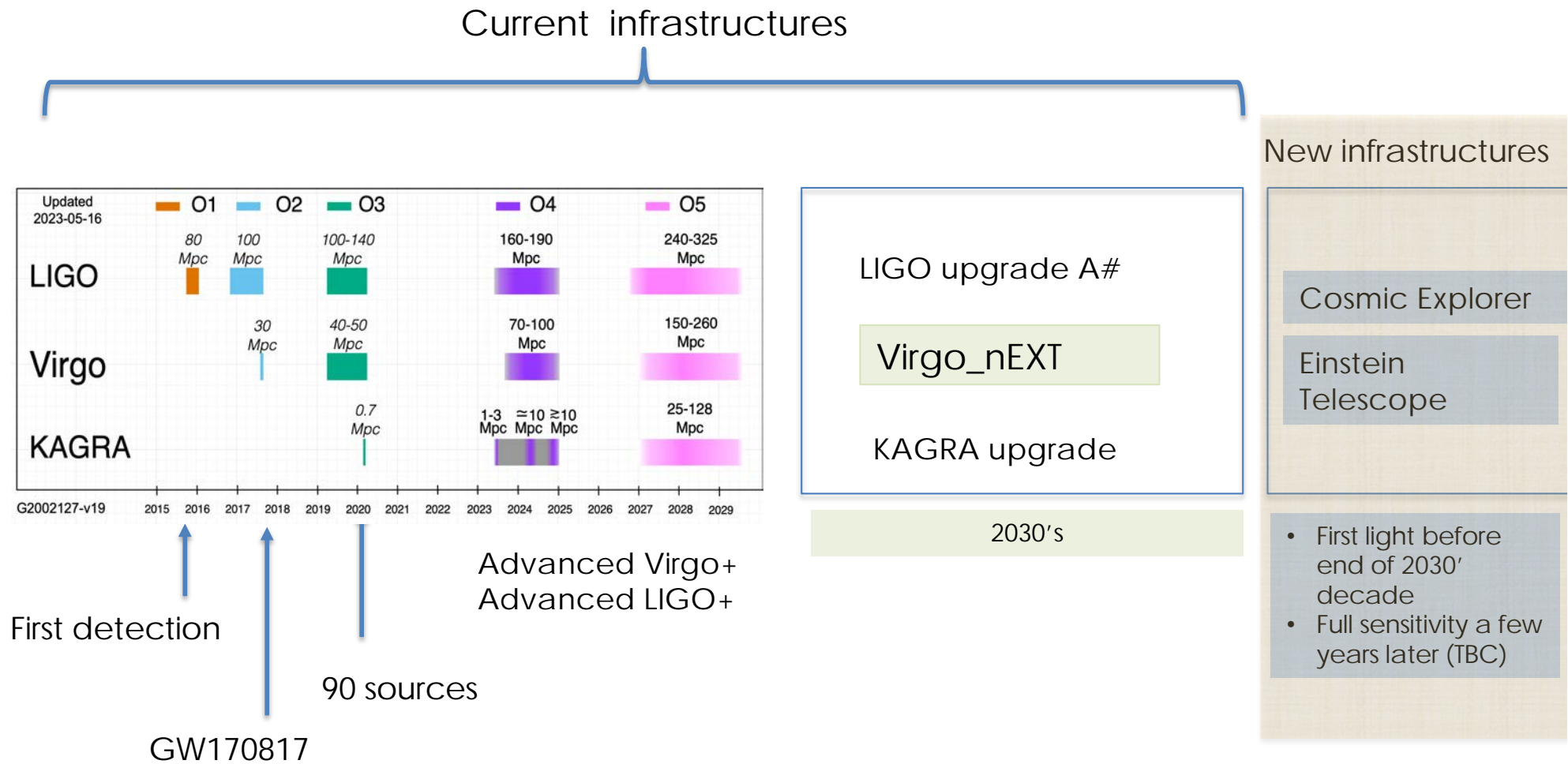

Einstein Telescope and Cosmic Explorer

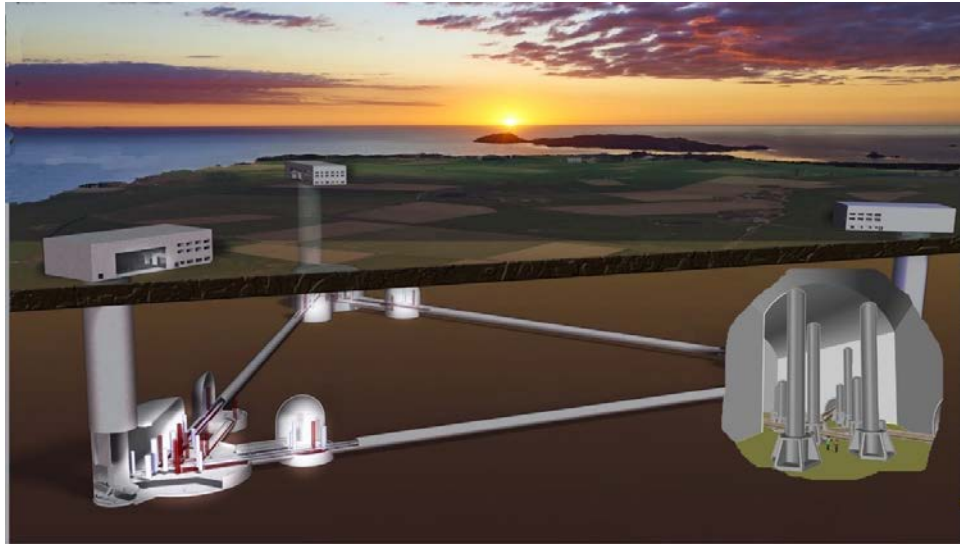

See Patrice Verdier talk

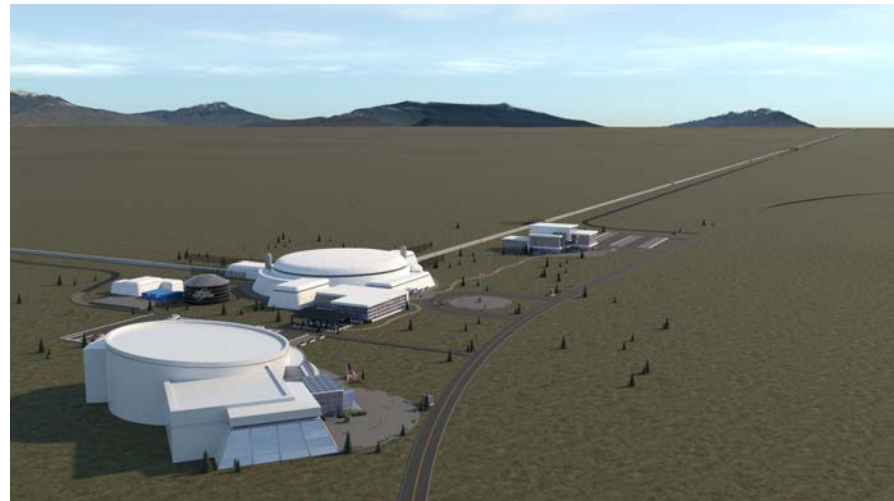

Ground based interferometric GW detectors

Dual recycled Fabry-Perot Michelson interferometers with suspended test masses and use of frequency dependent quantum squeezing

- Suspended test masses / seismic isolation
- Long arms, powerful lasers, suspended optical benches
- Quantum squeezing

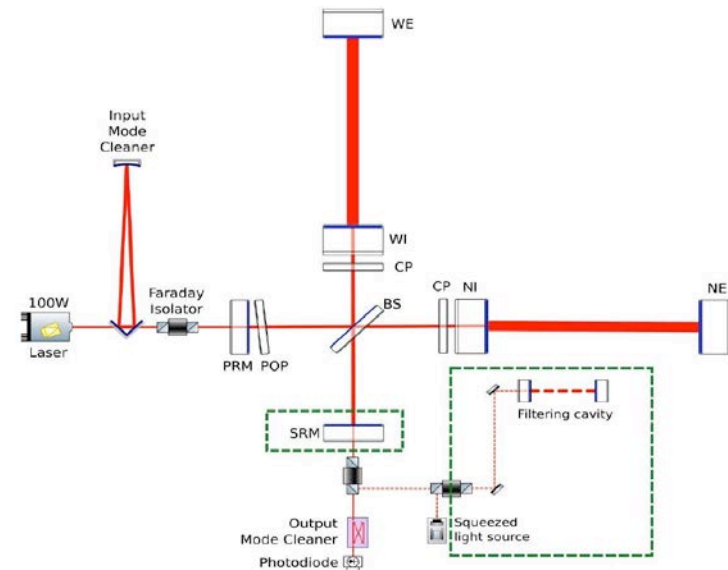
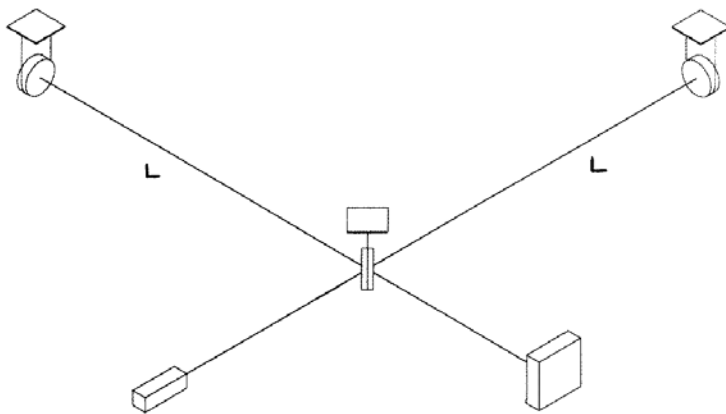

Suspensions and mirrors

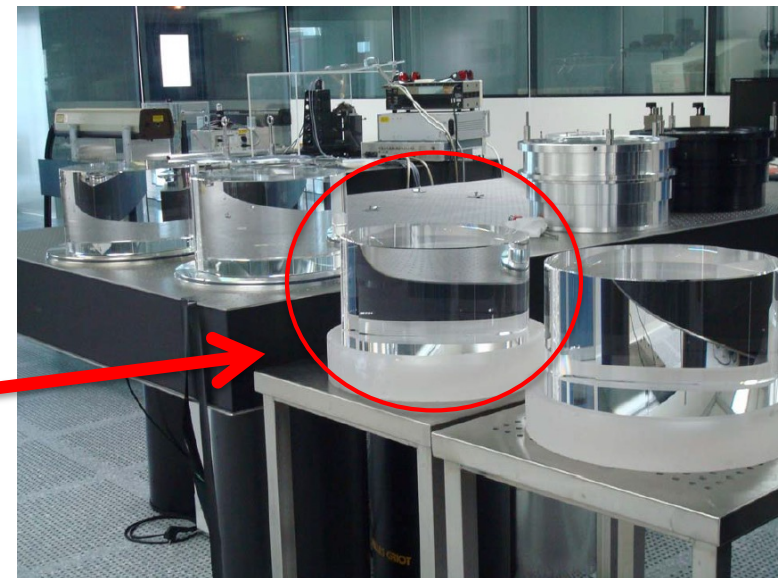
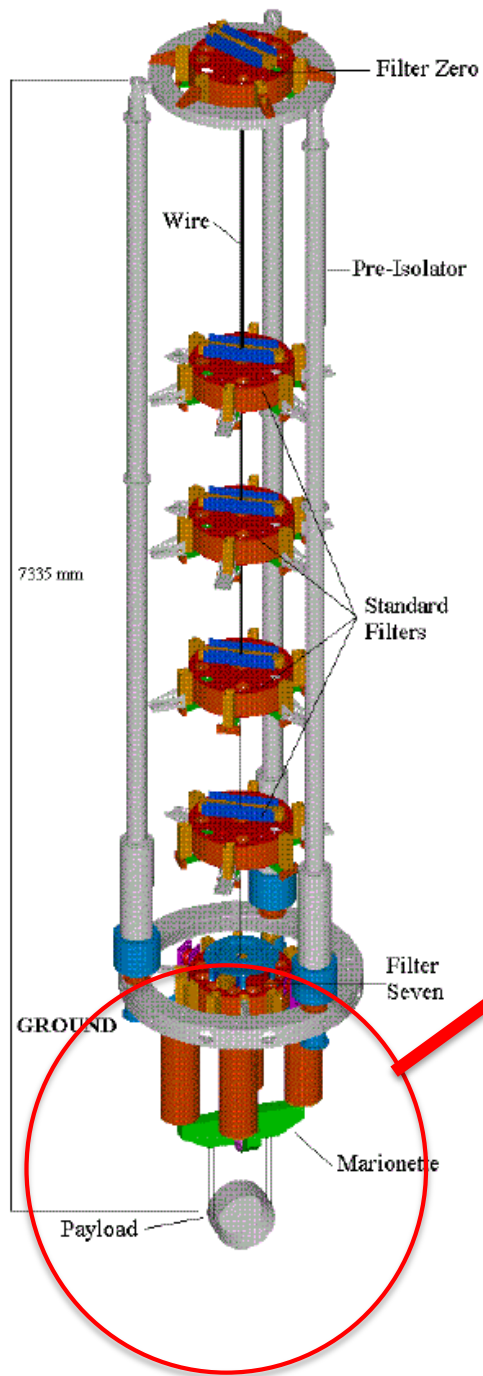

Fused silica 40 km blocks
Flatness < 1 nm RMS

Noise sources

A possible classification:

- **Fundamental noises (from *first principles*)**
 - Quantum, thermal
- **Technical noises**
 - Laser, electronics, vacuum pressure
- **Enviromental noises (from the environment)**
 - Seismic, acoustic, magnetic

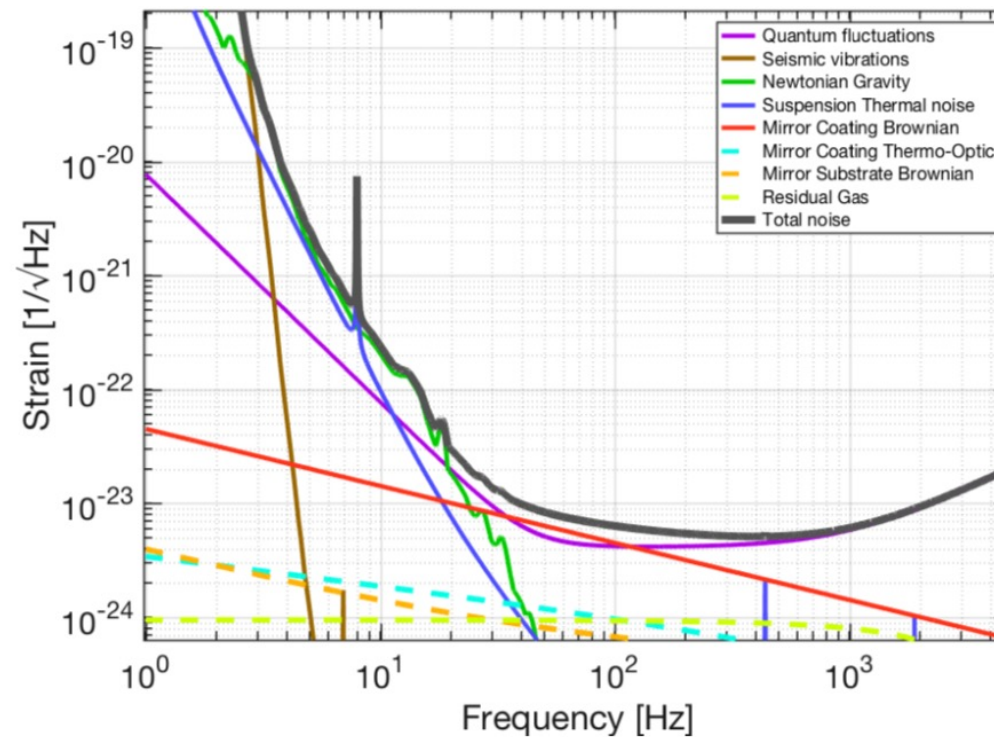

GW detectors and observing runs

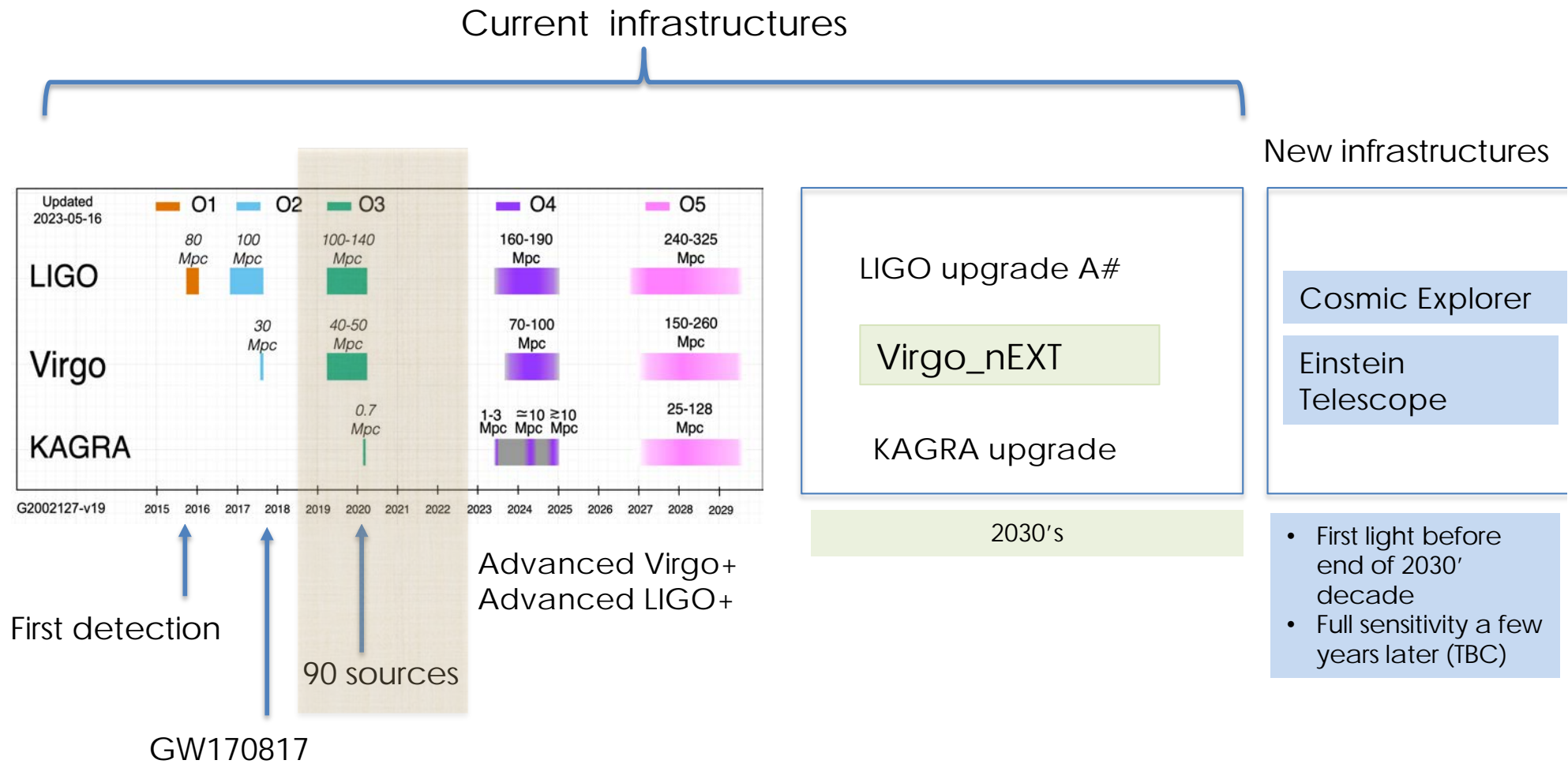

GWTC-3 (2021)

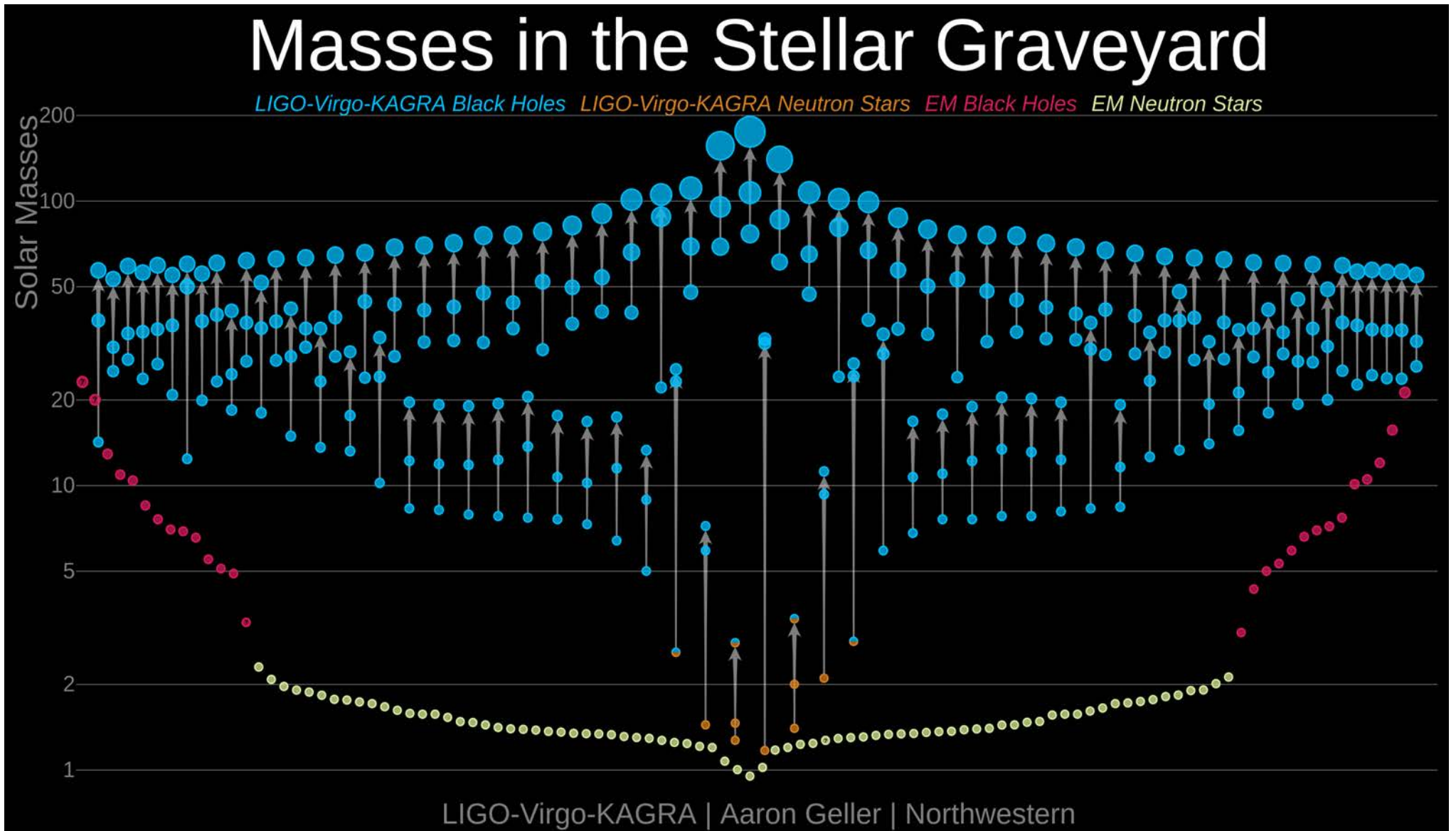

The last LVK data-taking (O3)

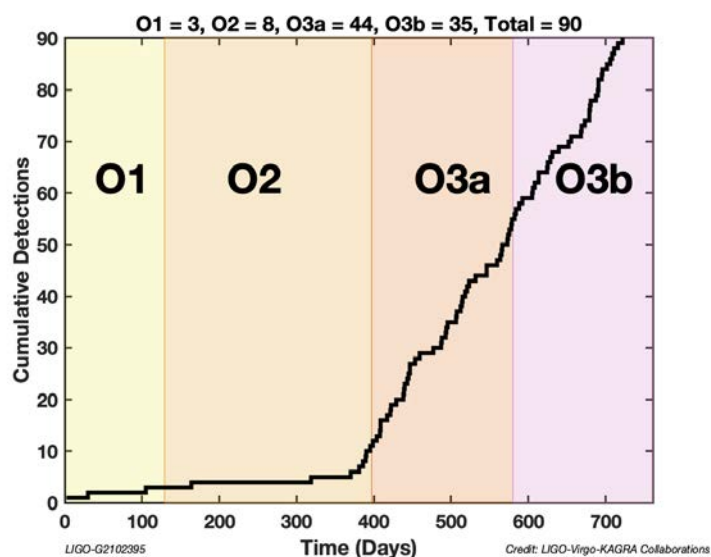

- 6 new exceptional astrophysical systems published
- More distant sources with respect to O2 ($z \sim \times 2$)
- New tests of general relativity (i.e. harmonics of the GW signal)
- A drastic change in slope in the number of sources
- Upper limits on several sources and physical effects (i.e. GW background, lensing, specific dark matter candidates)
- Population studies (not only study of individual events)

GW detectors and observing runs

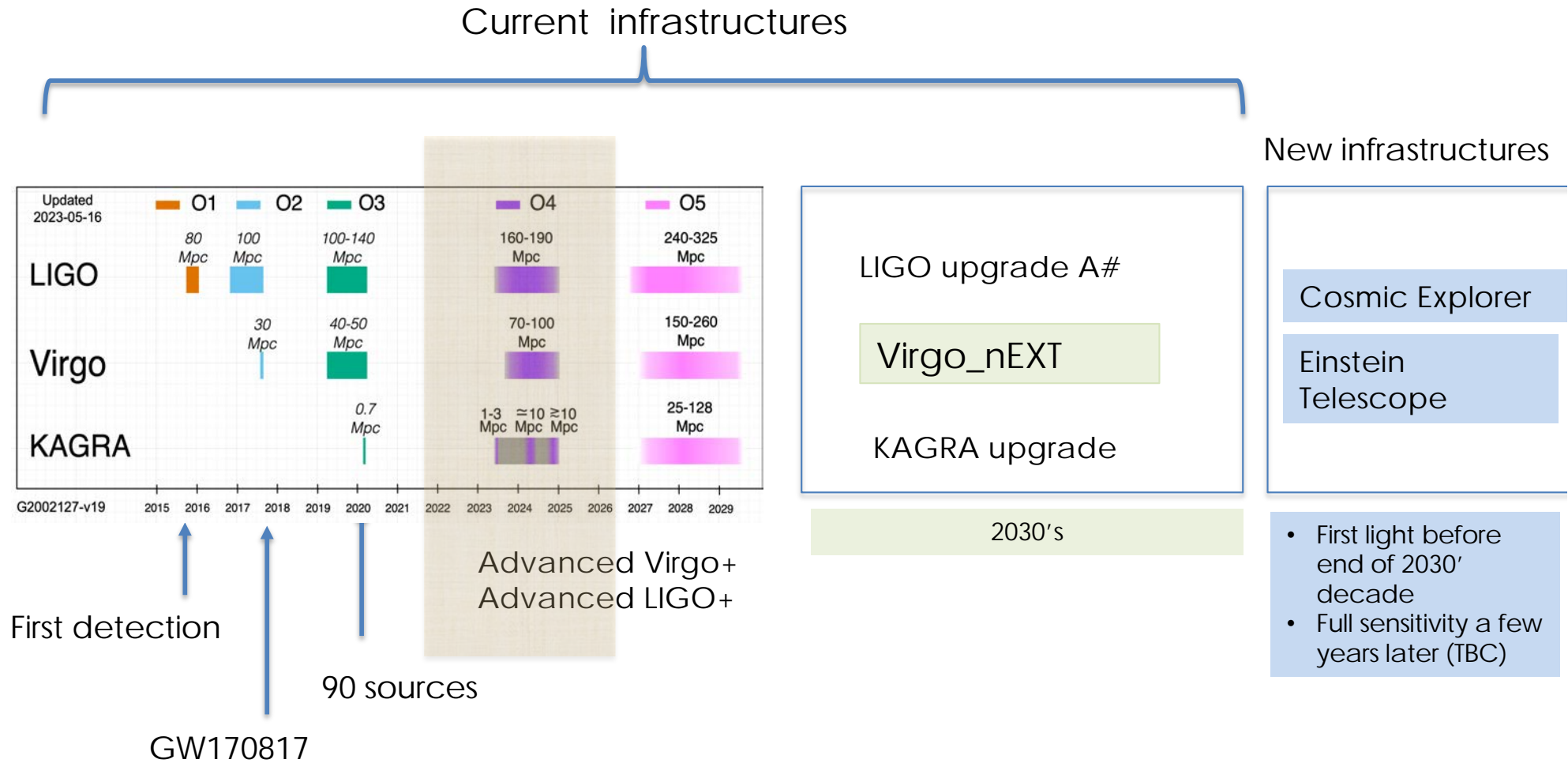

LVK - O4 data taking

- Started on May 24th 2023
- LIGO ~ 130-150 Mpc
- KAGRA started with ~ 1 Mpc – now in commissioning again
- Virgo ~27 Mpc in May → decided to not enter officially to continue commissioning
- Difficulties with optical configuration (marginally stable recycling cavities)
- Problems with 2 test masses
- Advanced Virgo+ plans to enter around September, following the commissioning progress

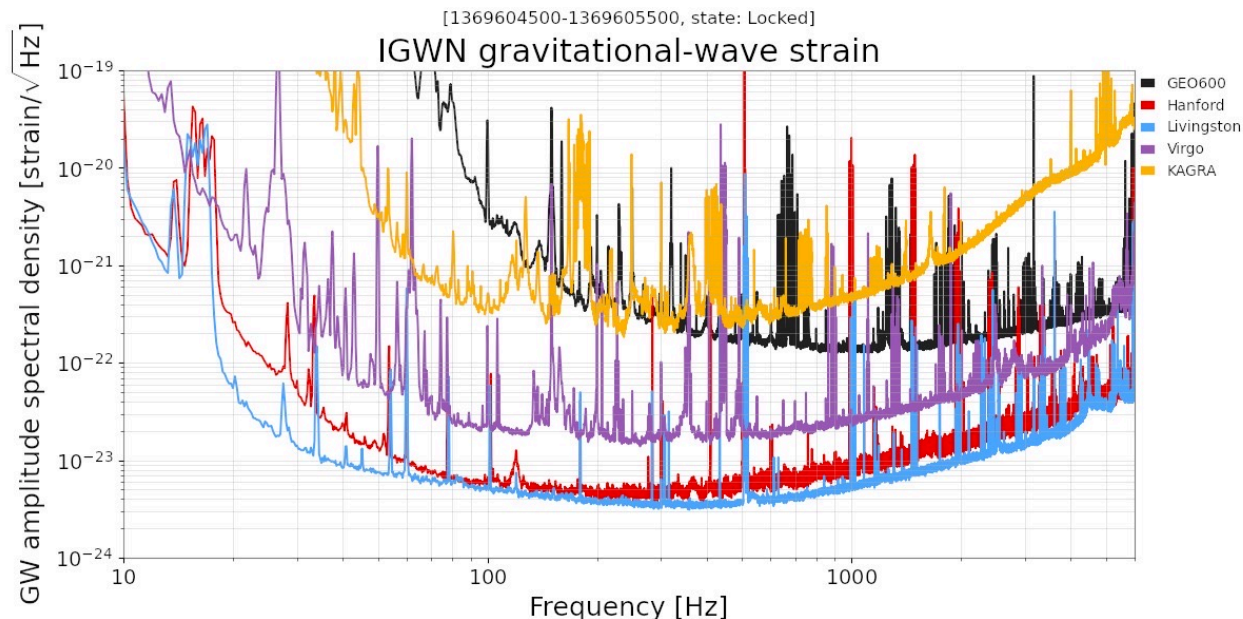

GW detectors and observing runs

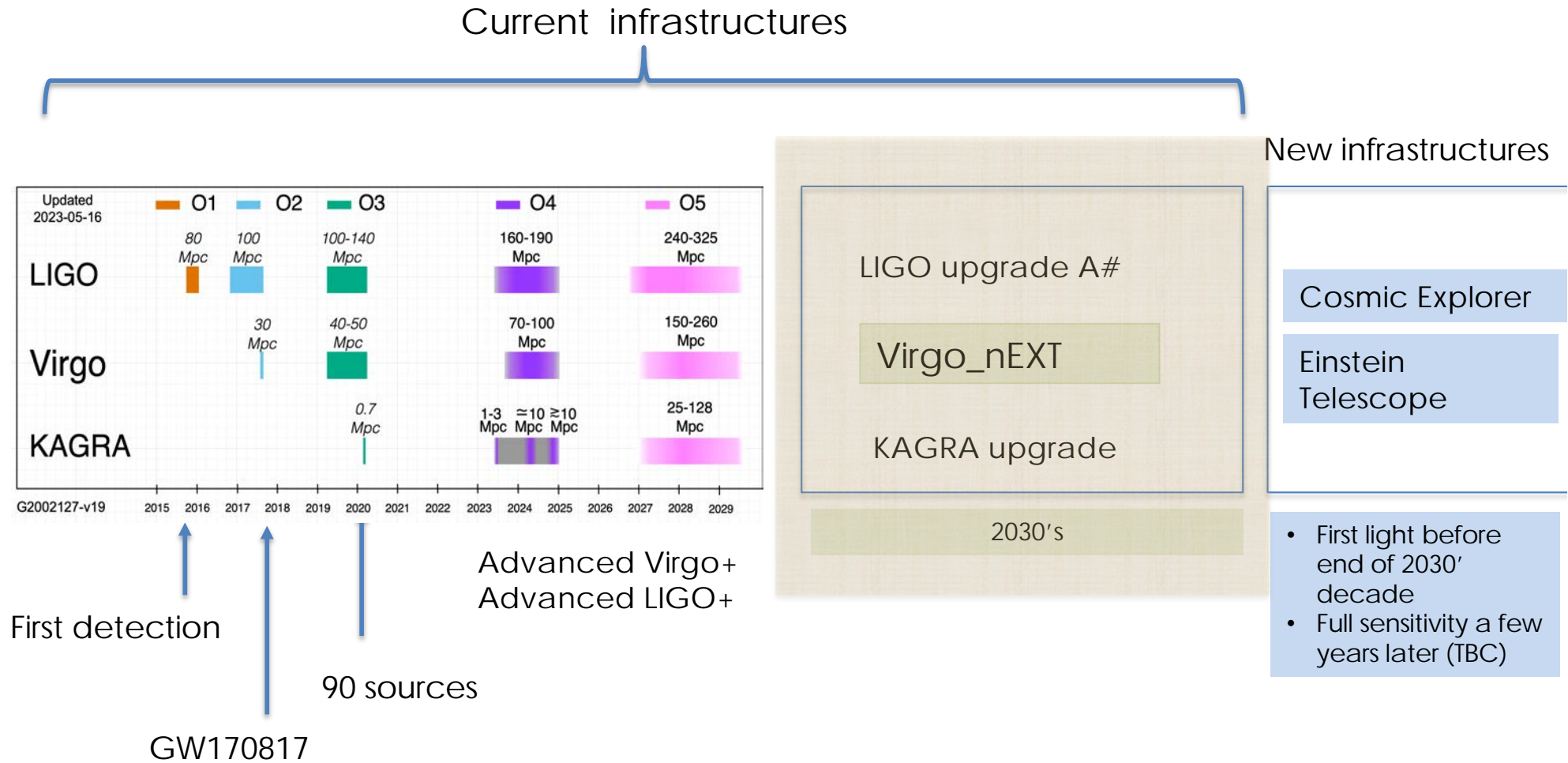

Virgo_nEXT history and schedule

Plan for R&D
in french labs
being finalized

- March 2021: Virgo_nEXT study initiated
- Two committees formed:
 - Committee 1: Scientific potential
 - Committee 2: Detector design
- March 2022: Virgo_nEXT Concept study released (140 pages document)
- June 2022: Virgo_nEXT presented to EGO council and French Research Ministry
- January 2023: Virgo_nEXT coordinator appointed
- January 2023: 2 committees formed to address two main points:
 - Coating options
 - Need of stable recycling cavities
- July 2023: Finalizing preliminary plan for R&D
- December 2024: Expected Virgo_nEXT Technical Design report
- 2024-2029: Virgo_nEXT R&D and components development
- 2029: end of O5 LVK data taking
- 2032-2033: Possible Virgo_nEXT first data taking

Virgo_nEXT history and schedule

Plan for R&D in french labs being finalized

- March 2021: Virgo_nEXT study initiated
- Two committees formed:
 - Committee 1: Scientific potential
 - Committee 2: Detector design
- March 2022: Virgo_nEXT Concept study released (140 pages document)
- June 2022: Virgo_nEXT presented to EGO council and French Research Ministry
- January 2023: Virgo_nEXT coordinator appointed
- January 2023: 2 committees formed to address two main points:
 - Coating options
 - Need of stable recycling cavities
- July 2023: Finalizing preliminary plan for R&D
- December 2024: Expected Virgo_nEXT Technical Design report
- 2024-2029: Virgo_nEXT R&D and components development
- 2029: end of O5 LVK data taking
- 2032-2033: Possible Virgo_nEXT first data taking

Sensitivity

AdV sensitivity evolution from O3 to Virgo_nEXT

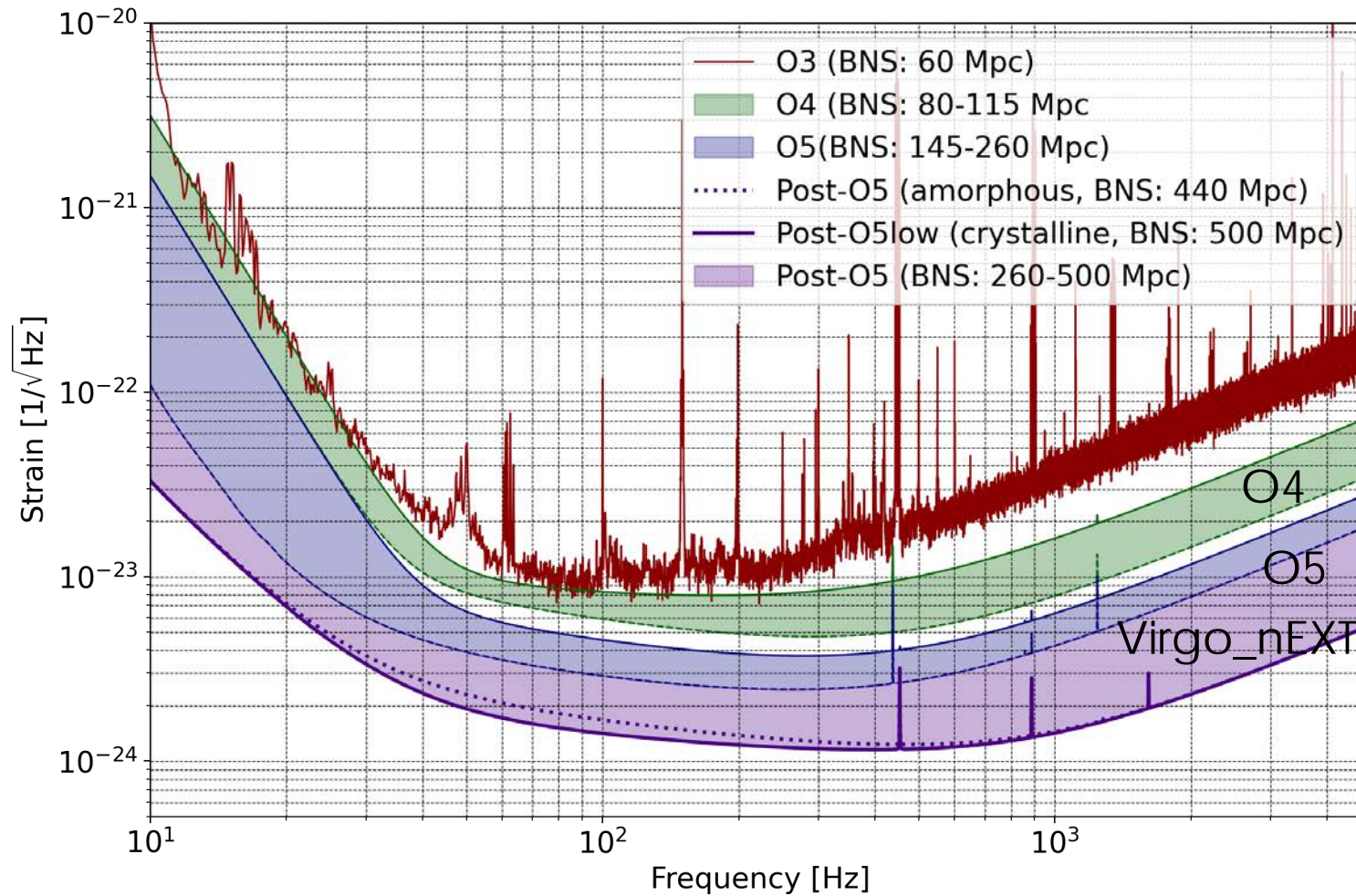

Why Virgo_nEXT

- 🔬 Continue Virgo's science programme in the LVK gravitational-wave detector network
- 🚀 Push the potential of the existing infrastructure to its limits
- 🔧 Test the technologies used in the ET avoiding design mistakes and accelerating commissioning
- 🕒 Fill a potential gap of a decade between the end of O5 and the first ET design sensitivity
- 👥 Keep and develop the expertise of the experimental and data analysis community
- ↔️ Ensure smooth generational transition and training of new leaders

Sensitivity vs science

AdV sensitivity evolution from O3 to Virgo_nEXT

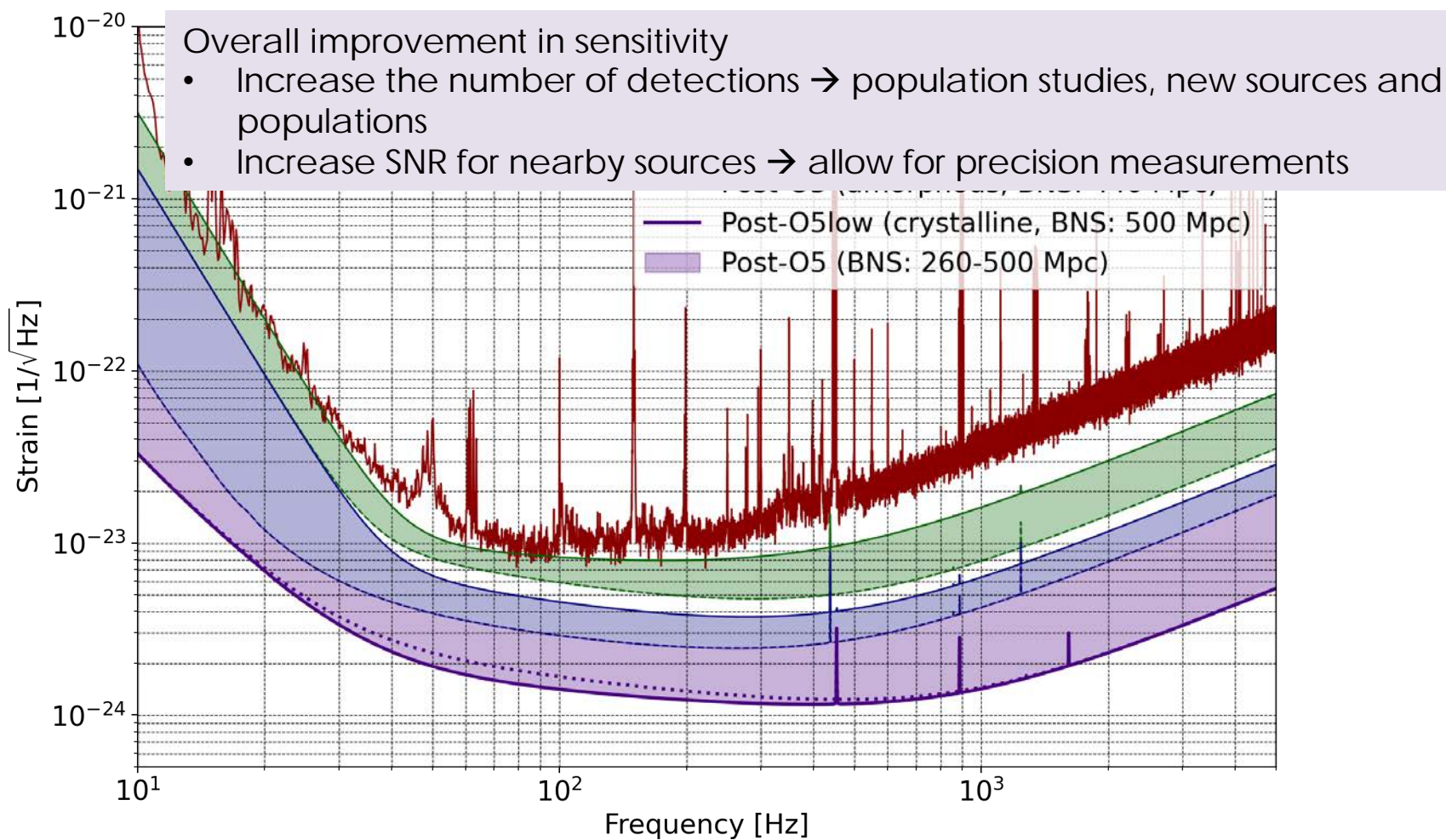

Sensitivity vs science

Improving low-frequency sensitivity

- For a given CBC source, measure more cycles of the chirp
→ more accurate source parameters
- Give access to more massive and/or more distant CBC sources

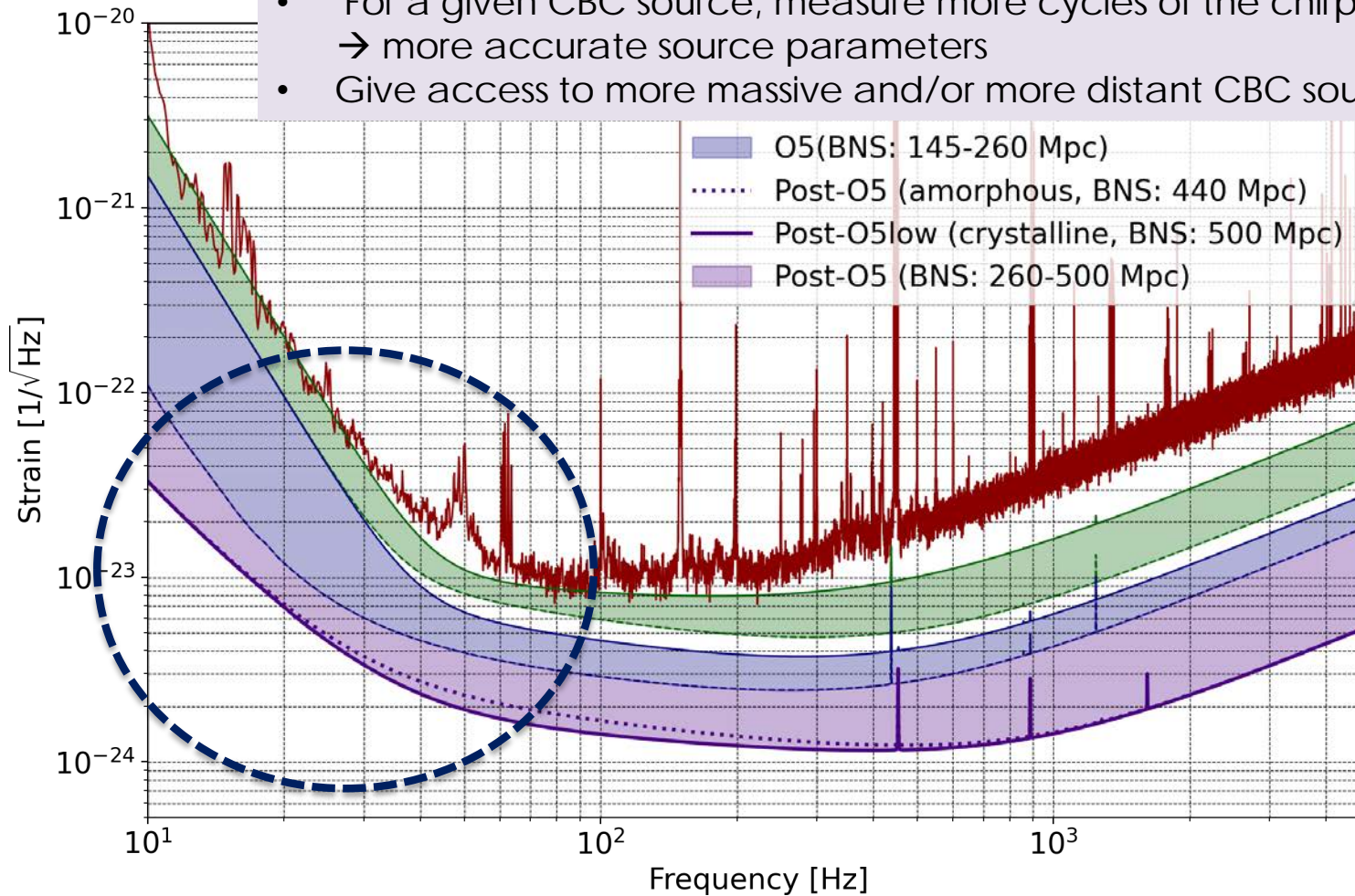

Sensitivity vs science

AdV sensitivity evolution from O3 to Virgo_nEXT

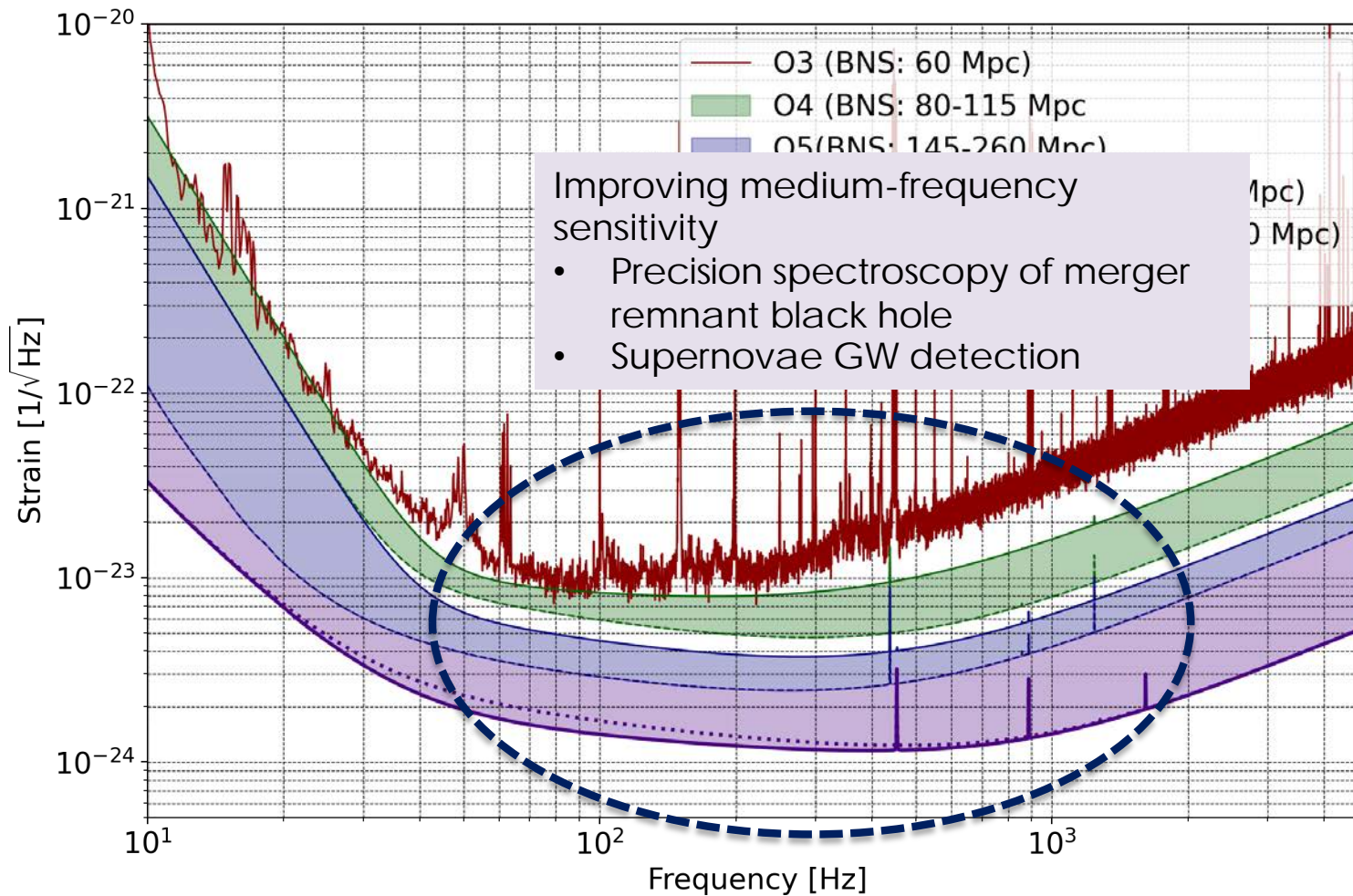

Sensitivity vs science

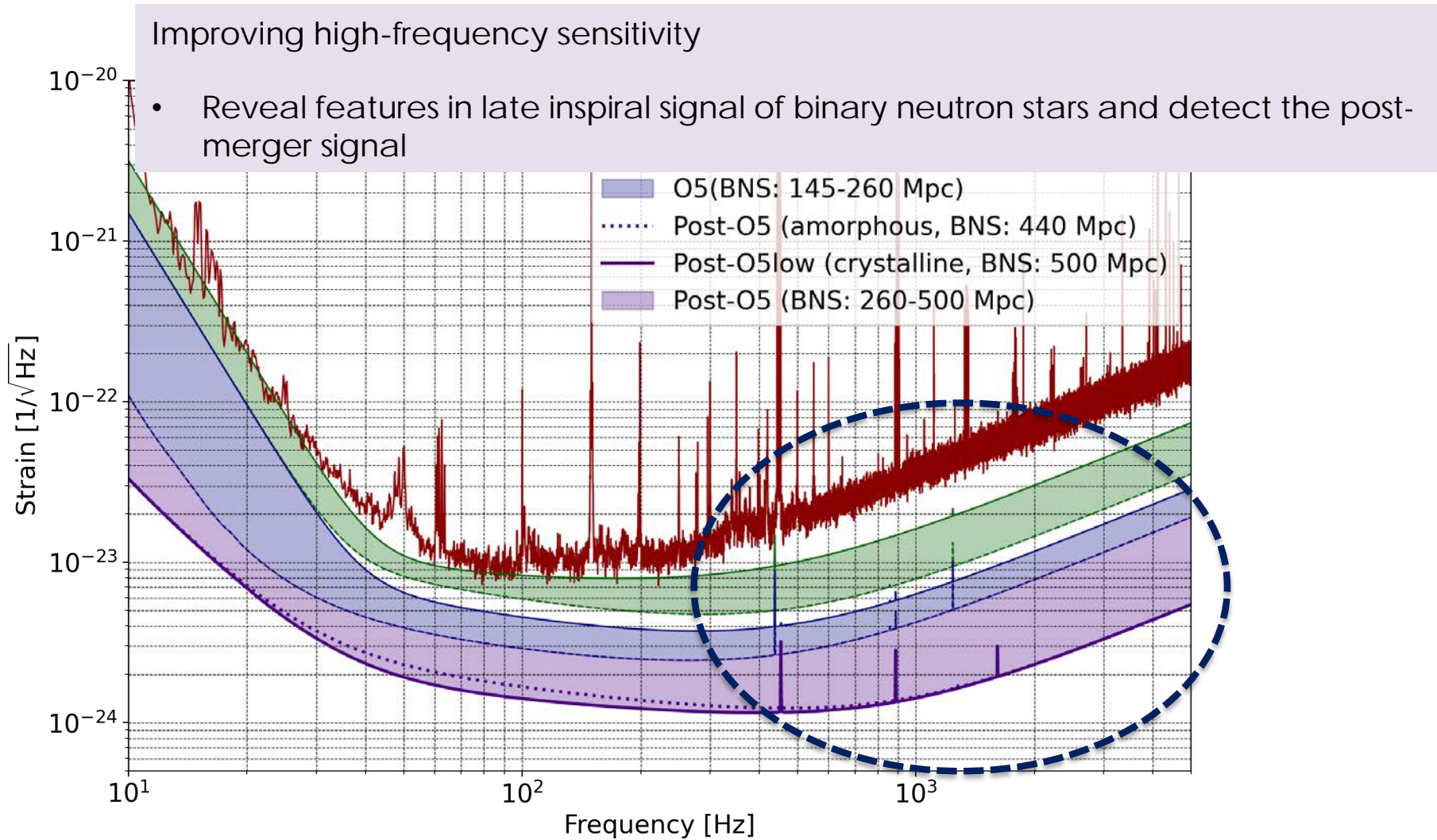

The science with Virgo_nEXT compact objects

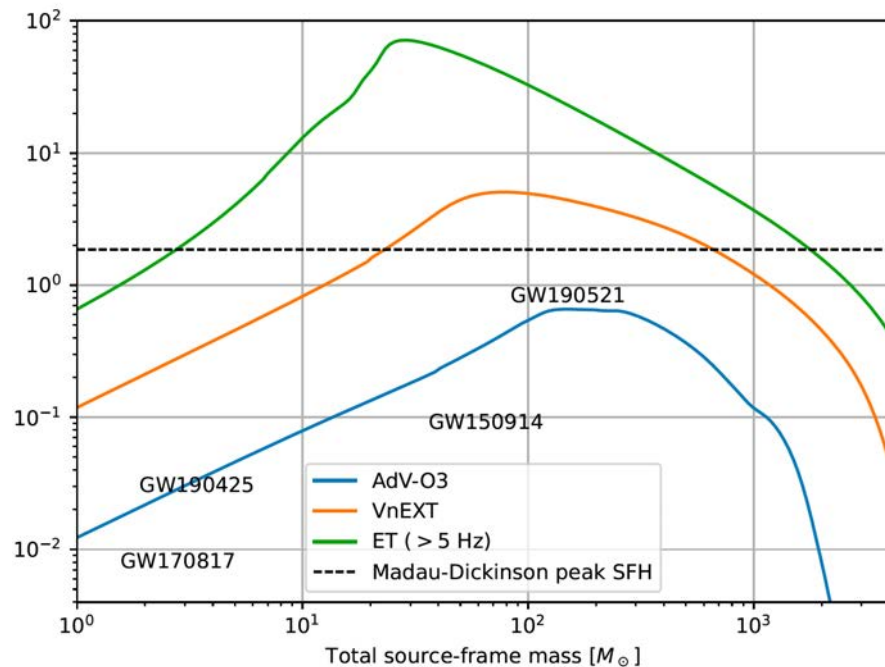

O3 (AdV) $\sim O(10^2)$ BBH /year
O5 (AdV+) $\sim O(10^3)$ BBH/year

"O6" (upgraded network)

$\sim O(10^4)$ BBH/year
 $\sim O(10^3)$ BNS /year

Possible GW detector network after 2030 (Virgo_nEXT, A#, KAGRA)

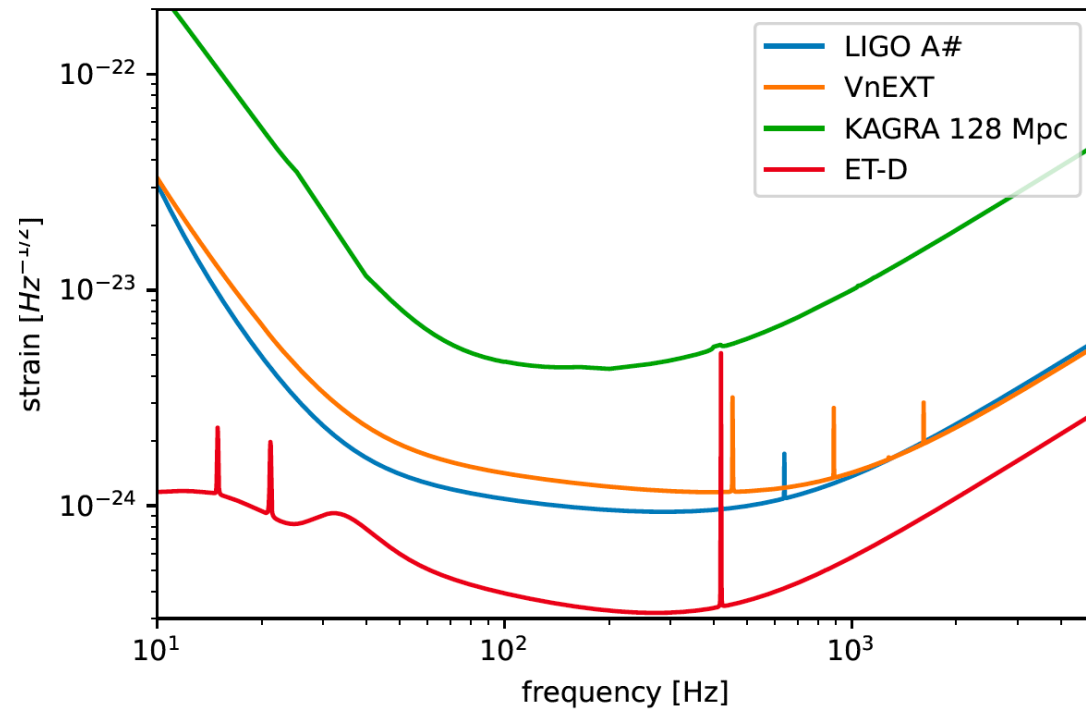
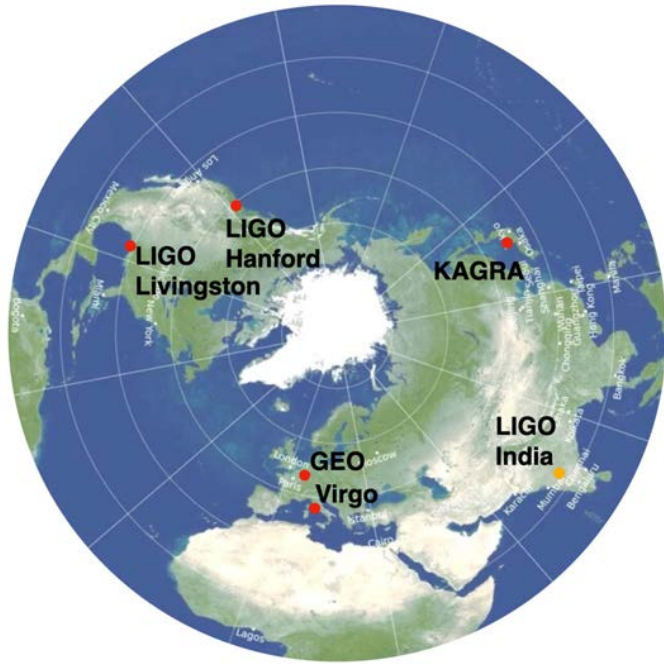

Science case

- Discovery potential
 - Cosmology - H_0
 - Nuclear physics – phase transitions
 - Isolated spinning neutron stars
 - Astrophysical stochastic background
 - Ringdown – nature of black-holes
 - Post-merger signal
- Constraints (or surprises)
 - Test of general relativity
 - Dark matter
 - Black-hole distributions / population sciences
 - Supernovae
- Multi-messenger astrophysics
 - GRB, FRB, kilonovae
 - Alerts
 - Synergies with other observatories

Cosmology: Measurement of H_0

With e.m. counterpart (GW170817)

- GW gives luminosity distance
- e.m. counterpart gives redshift

Without e.m. counterpart (dark sirens) and galaxy catalogs

- Statistical analysis using redshifts from galaxies catalog
- Only with GW (spectral sirens)
 - Distribution of BH masses

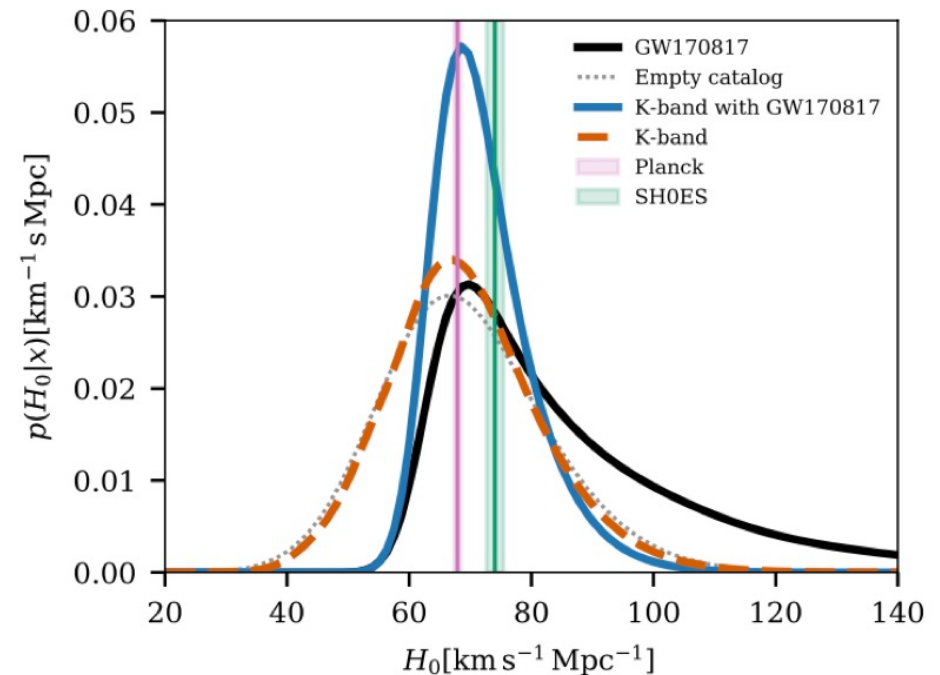

Cosmology: Measurement of H_0

e.m. counterparts and galaxy catalogs

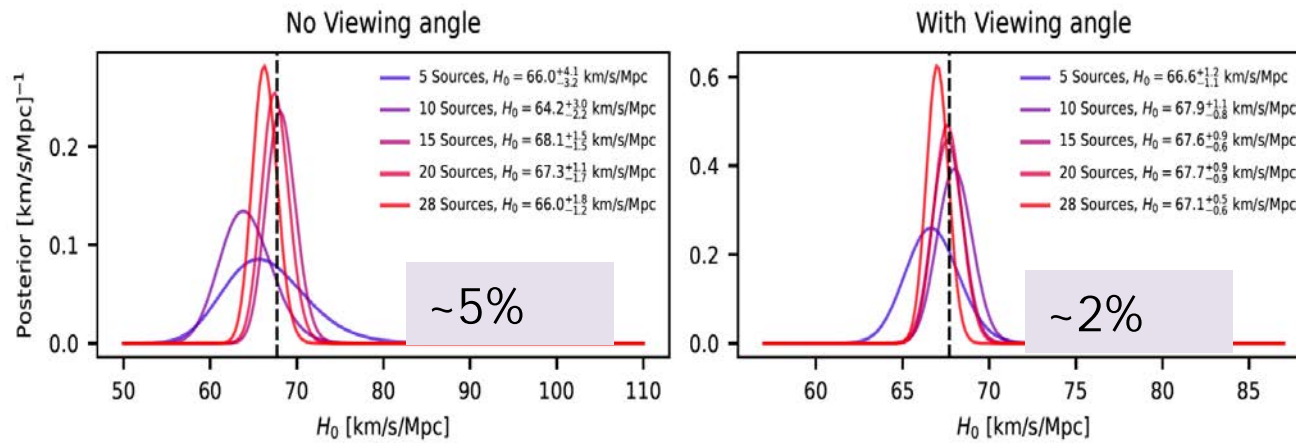

- ~ 30 BNS/year with Kilonova observed by Vera Rubin
- SNR=12

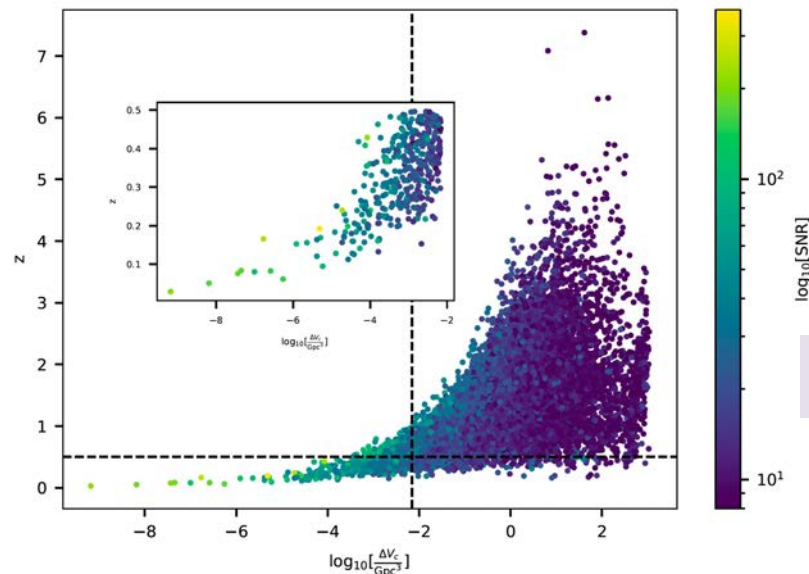

- ~ 150 BBH/year with galaxy catalogs (50%)
- Cut on localization and redshift

Cosmology: Measurement of H_0

Spectral sirens

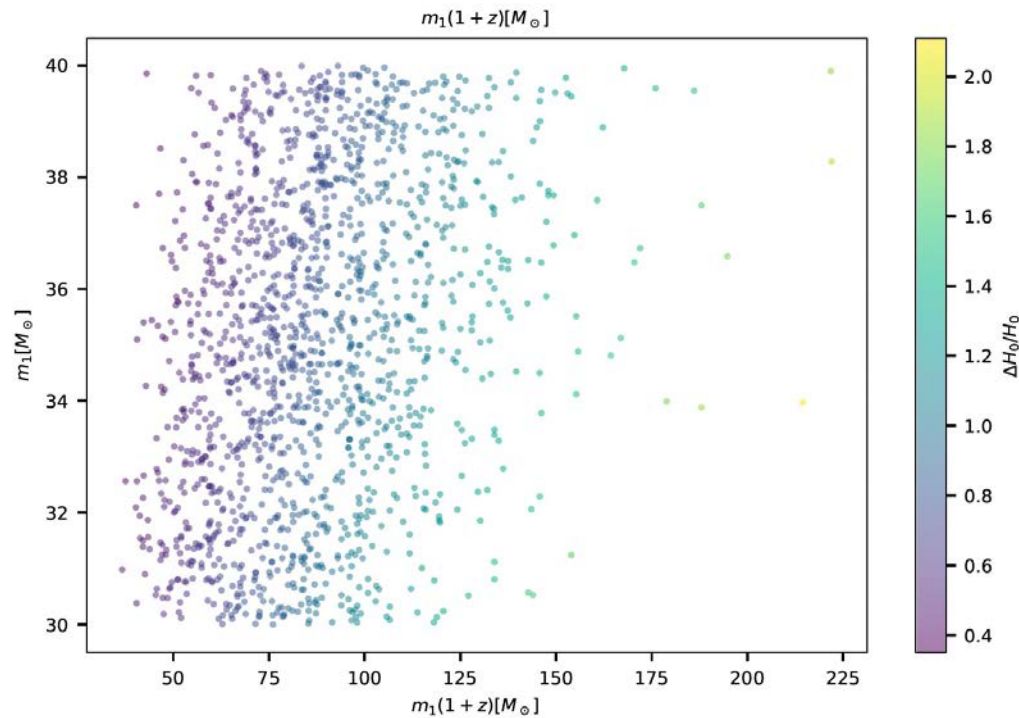

~3%

- Combination of ~ 8000 BBH
- Overdensities in the mass distribution

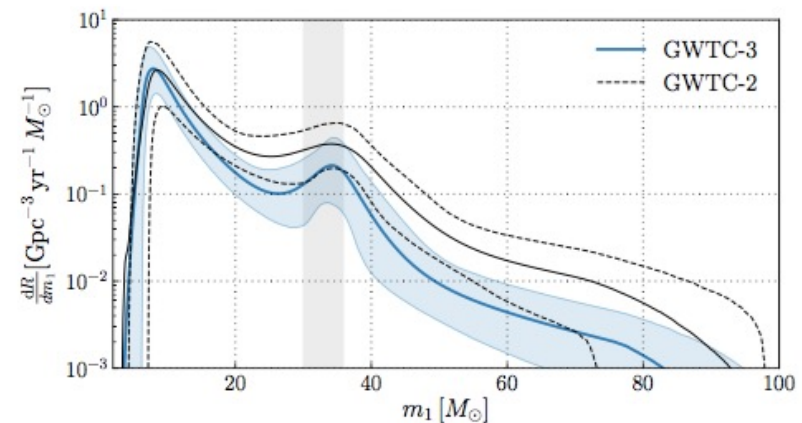

Nuclear physics

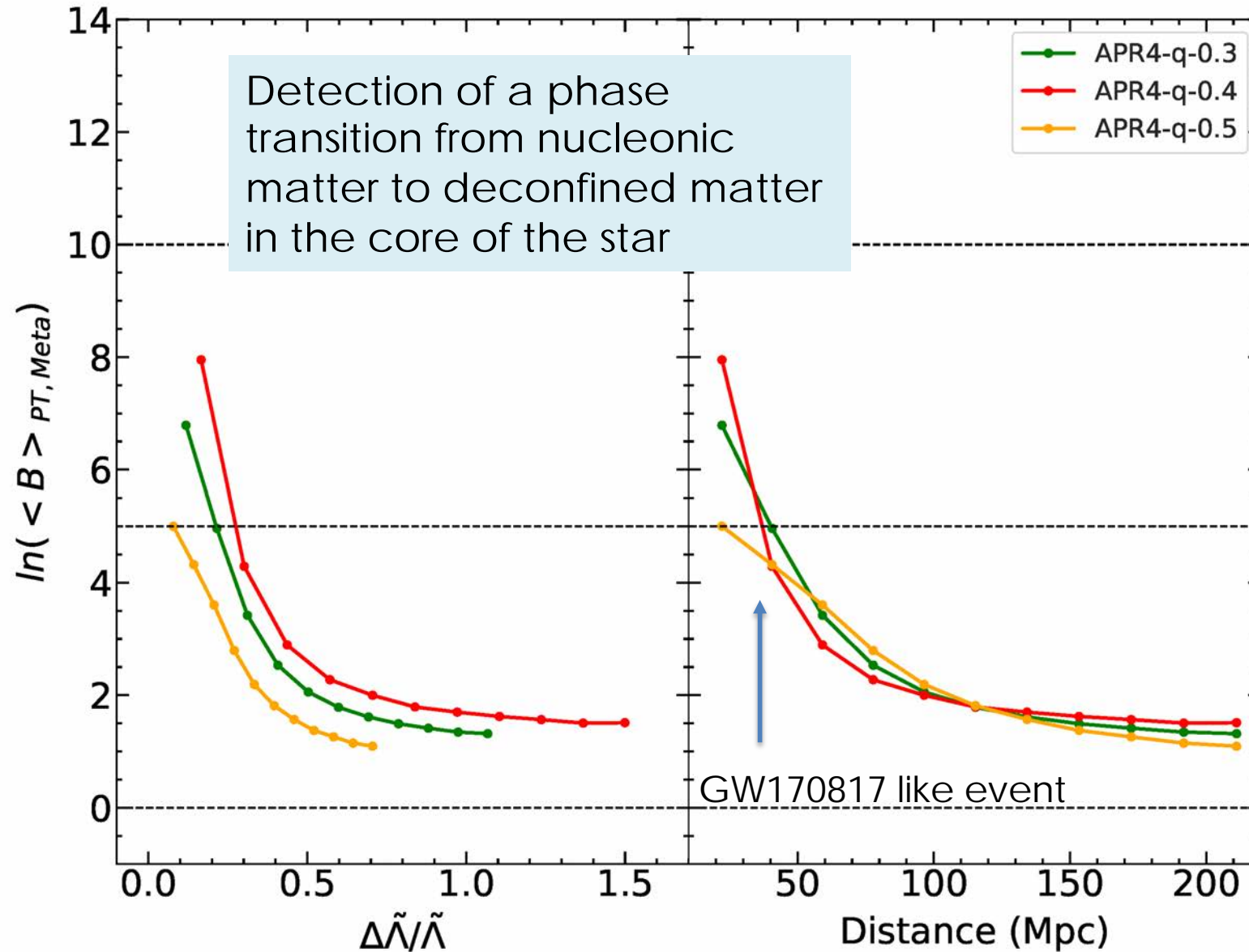

Isolated spinning neutron stars

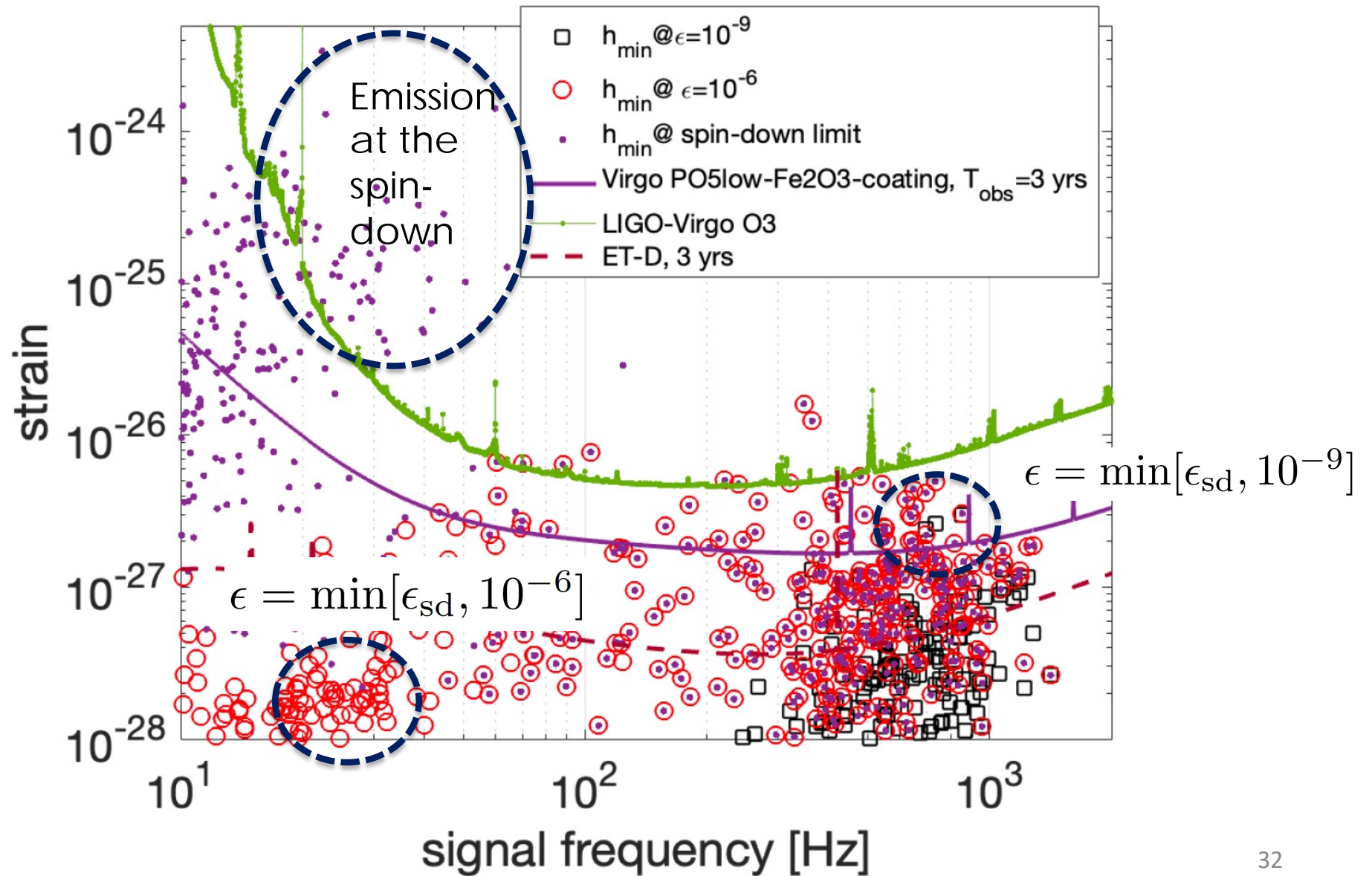

Stochastic background

- Results from the superposition of weak and independent sources
- Using cross correlation techniques with $A\#$, we are ensured to detect the contribution from BBHs at a level of 5σ a in a few years with Virgo_nEXT
- Complementary to individual detections (probe the high redshift population)
- Upper limit (or detection) on a flat cosmological background (inflation, cosmic string) at the level of $\Omega \sim 10^{-10}$

Science case

- Discovery potential
 - Cosmology - H_0
 - Nuclear physics – phase transitions
 - Isolated spinning neutron stars
 - Astrophysical stochastic background
 - Ringdown – nature of black-holes
 - Post-merger signal
- Constraints (or surprises)
 - Test of general relativity
 - Dark matter
 - Black-hole distributions / population sciences
 - Supernovae
- Multi-messenger astrophysics
 - GRB, FRB, kilonovae
 - Alerts
 - Synergies with other observatories

Tests of General relativity

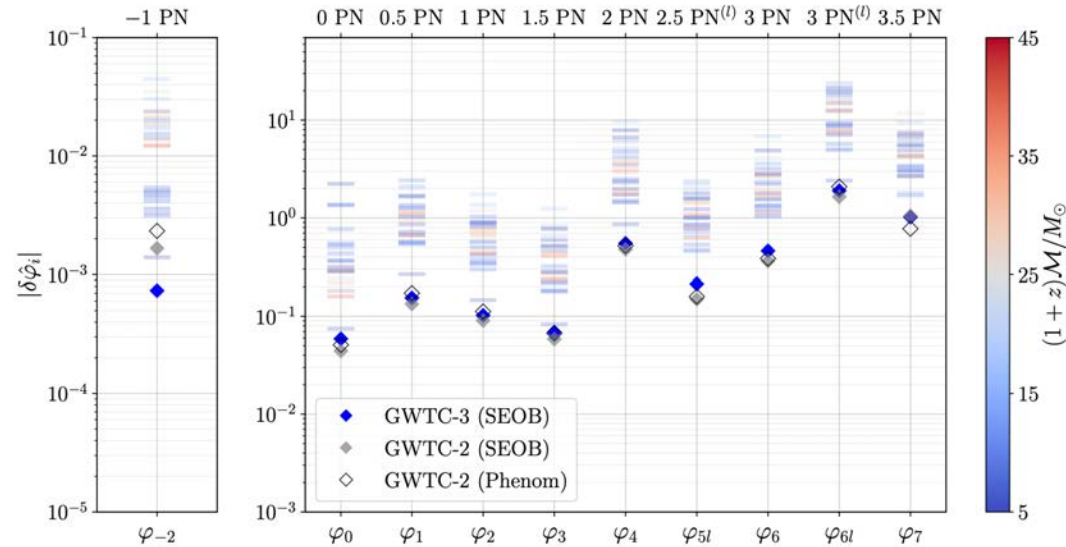

Tests of General Relativity with GWTC-3, B.P. Abbott et al

- Parametric deviations constraints will improve with $1/\text{SNR}$
- Detection of separate ringdown modes may be achievable: **testing the black hole nature of the remnant**
- High-SNR network detections will constrain scalar and vector polarizations

Dark matter

- GW signals from coalescence of **primordial black holes or exotic objects (partly composed of DM)**
 - Search for sub-solar mass compact objects with standard CBC techniques, in absence of observations, constrain DM models
- Probing DM through **gravitational lensing**
 - Given expected number of observation, chances are that Virgo_nEXT will bring GW lensing detections
 - Strongly lensed gravitational waves signals can probe the spatial distribution of DM
- **Gravitational waves interferometers as DM detectors**
 - E.g. direct searches for DM dark photons coupling to the interferometer

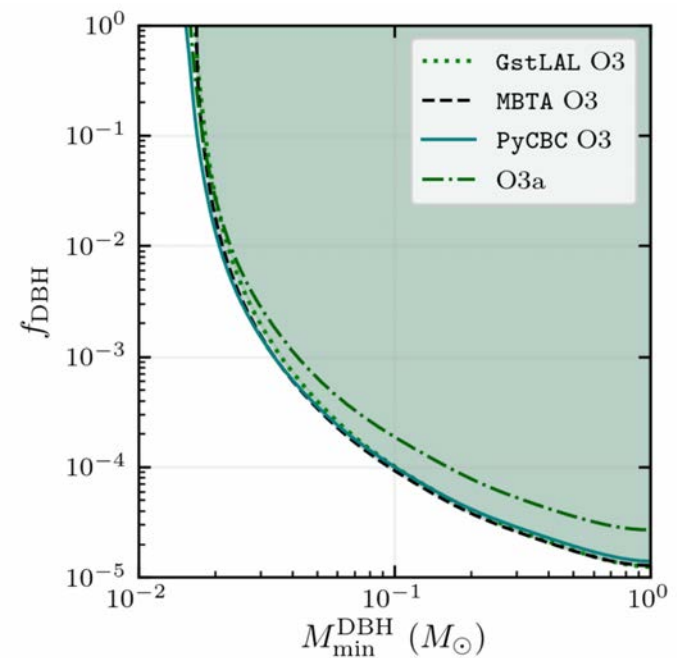

Constraints on abundance of
Dark Black Holes
[MNRAS, stad588](#)

Distribution of BH in binaries

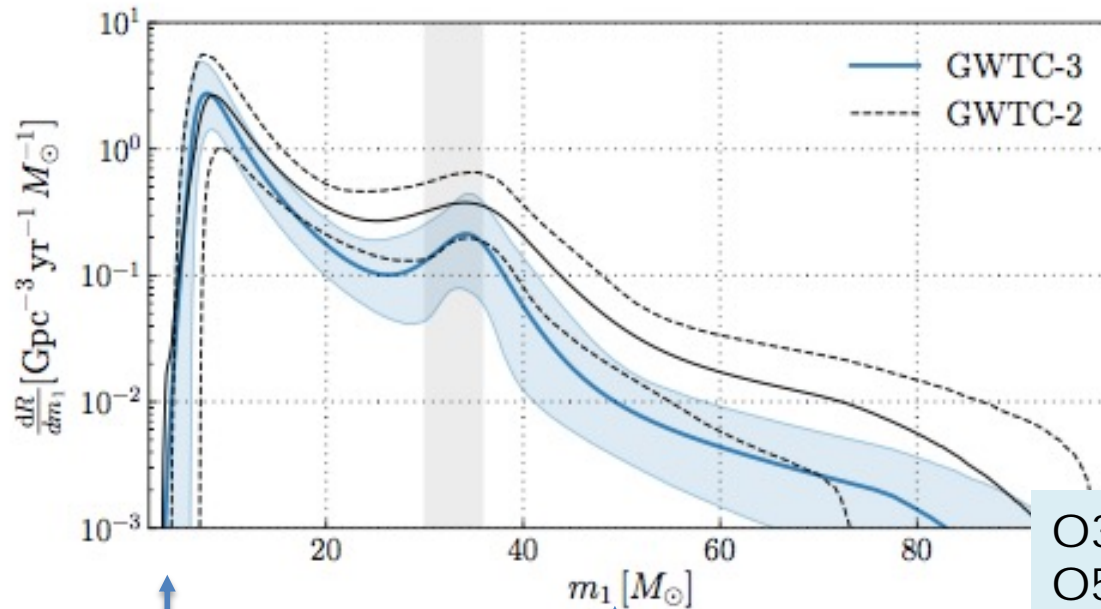

The population of merging compact binaries inferred using gravitational waves through GWTC-3, LIGO/Virgo/KAGRA Collaborations, [arXiv:2111.03634](https://arxiv.org/abs/2111.03634)

O3 (AdV) ~ $O(10^2)$ BBH /year
 O5 (AdV+) ~ $O(10^3)$ BBH/year

“O6” (upgraded network)

~ $O(10^4)$ BBH/year
 ~ $O(10^3)$ BNS /year

Lower mass gap?

Higher mass gap?

Science case

- Discovery potential
 - Cosmology - H_0
 - Nuclear physics – phase transitions
 - Isolated spinning neutron stars
 - Astrophysical stochastic background
 - Ringdown – nature of black-holes
 - Post-merger signal
- Constraints (or surprises)
 - Test of general relativity
 - Dark matter
 - Black-hole distributions / population sciences
 - Supernovae
- Multi-messenger astrophysics
 - GRB, FRB, kilonovae
 - Alerts
 - Synergies with other observatories

Multi-messenger astrophysics

- 5-detector network: excellent localization
- Synergies with e.m. observatories:
 - Vera Rubin
 - THESEUS
 - ATENA
- Larger distances and larger rates of events
- Importance for GRB, FRB and kilonovae

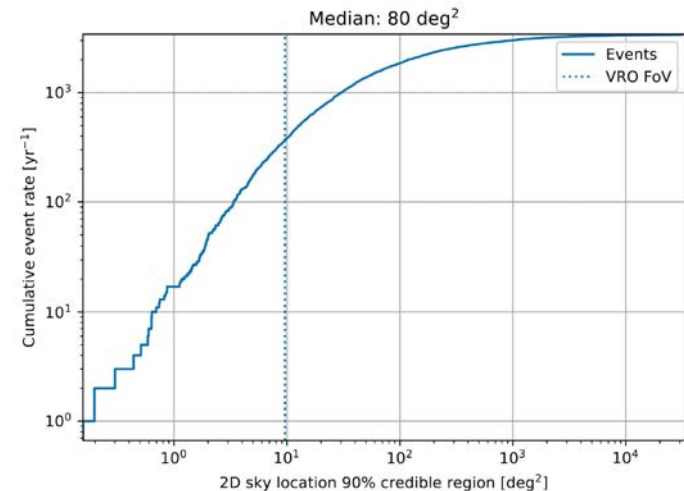

O3 (AdV) ~ O(10²) BBH /year
O5 (AdV+) ~ O(10³) BBH/year

“O6” (upgraded network)

~ O(10⁴) BBH/year
~ O(10³) BNS /year

Why Virgo_nEXT

- 🧪 Continue Virgo's science programme in the LVK gravitational-wave detector network
- 🚀 Push the potential of the existing infrastructure to its limits
- 🔧 Test the technologies used in the ET avoiding design mistakes and accelerating commissioning
- 🕒 Fill a potential gap of a decade between the end of O5 and the first ET design sensitivity
- 👥 Keep and develop the expertise of the experimental and data analysis community
- ↔️ Ensure smooth generational transition and training of new leaders

Detector concept

- 1.5 MW power in the cavities
- 10 dB squeezing
- New coatings
- Lower technical noises
- Larger input test masses
- Stable recycling cavities

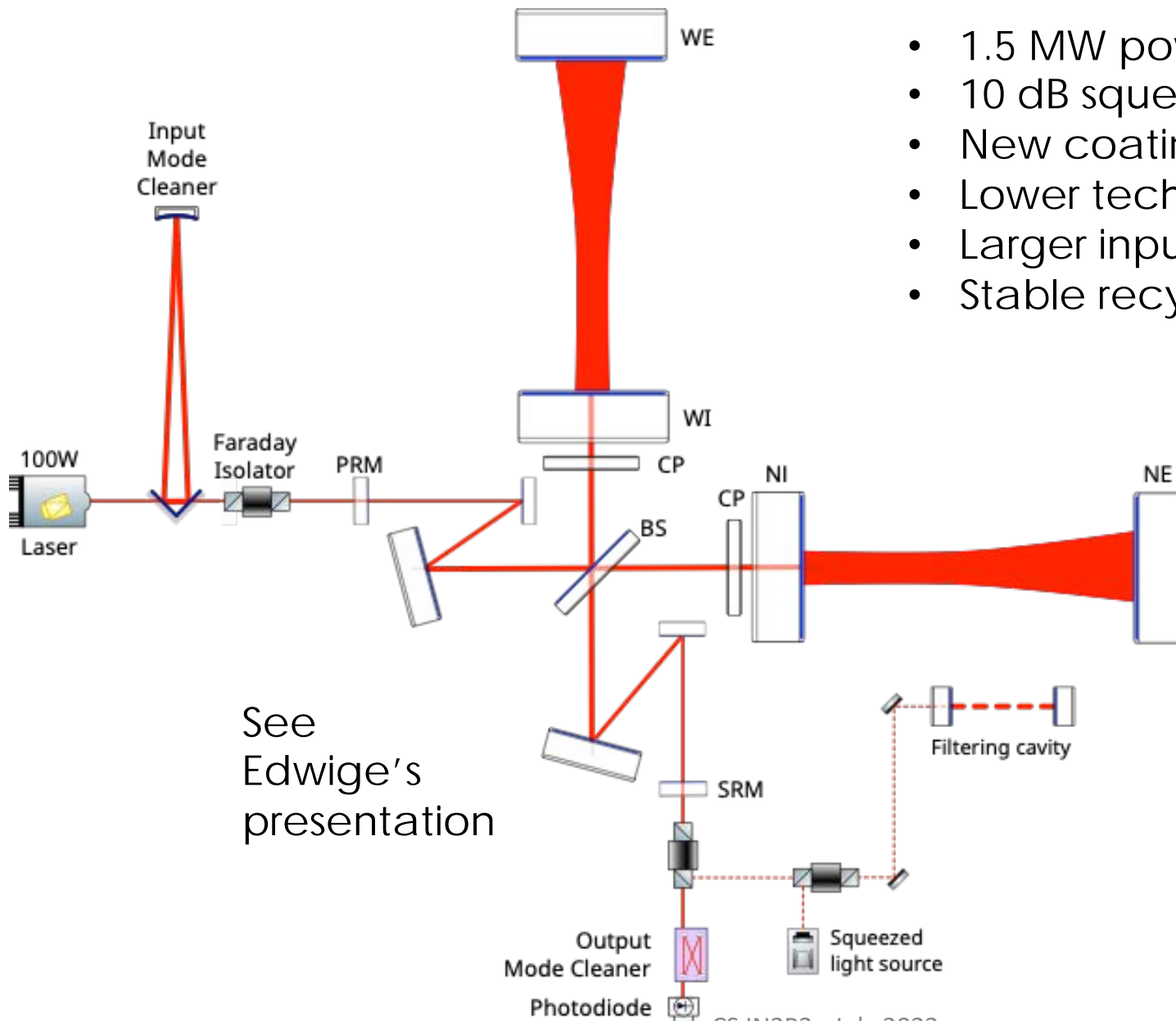

See Edwige's presentation

Main Virgo_nEXT parameters

Parameter	O4 high	O4 low	O5 high	O5 low	VnEXT low
Power injected (W)	23 W	40 W	60 W	80 W	277 W
Arm power	120 kW	190 kW	290 kW	390 kW	1.5 MW
PR gain	34	34	35	35	39
Finesse	446	446	446	446	446
Signal recycling	Yes	Yes	Yes	Yes	Yes
Squeezing type	FIS	FDS	FDS	FDS	FDS
Squeezing (db)	3	4.5	4.5	6	10.5
Payload type	AdV	AdV	AdV	AdV	Triple
ITM mass (kg)	42	42	42	42	105
ETM mass (kg)	42	42	103	103	103
ITM beam radius (mm)	49	49	49	49	49
ETM beam radius (mm)	58	38	91	91	91
Coating losses ETM	2.37e-4	2.37e-4	2.37e-4	7.90e-5	6.2e-6
Coating losses ITM	1.63e-4	1.63e-4	1.63e-4	5.40e-5	6.2e-6
Reduction NN	None	1/3	1/3	1/5	1/5
Technical noise	“high”	“low”	“low”	None	None
BNS range (Mpc)	90	115	145	260	500

Stable cavities

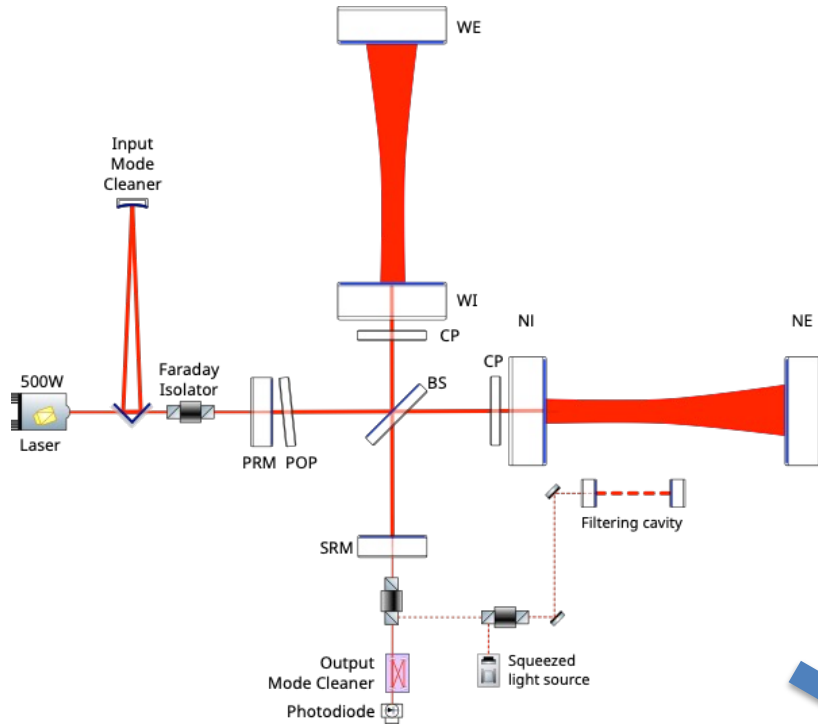

Marginally stable recycling cavities configuration (now)



Stable cavity configuration

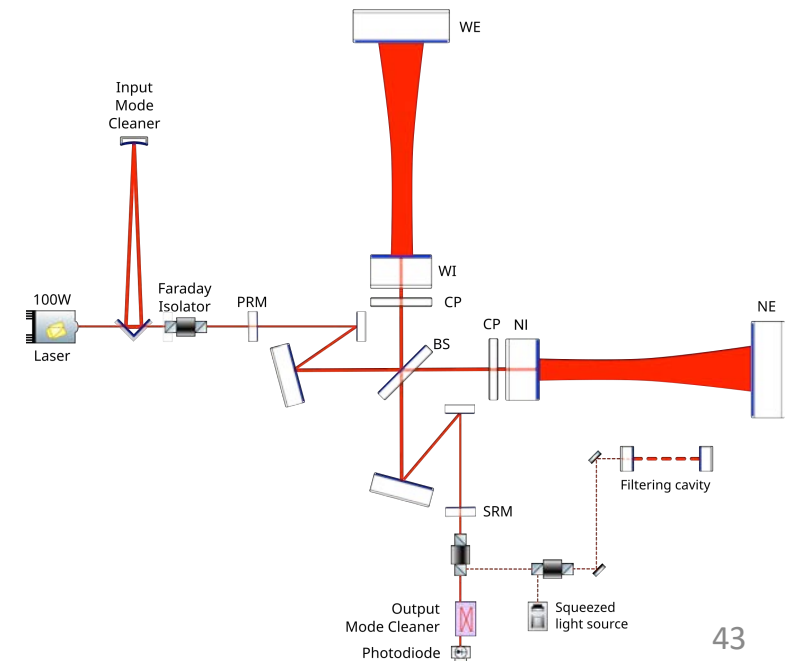

Recycling cavities

Power recycling cavity: increase stored power and reduce shot noise

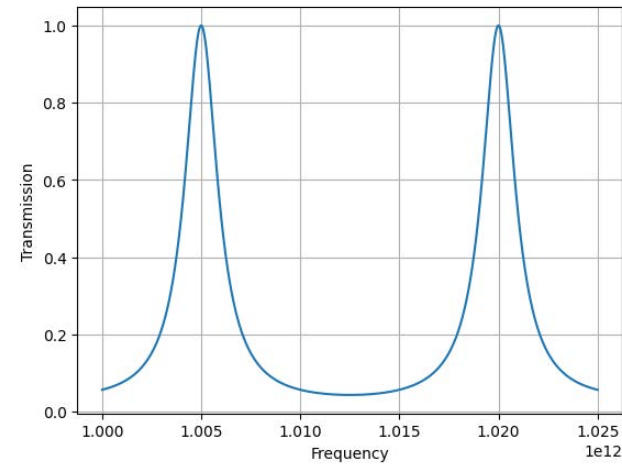

Signal recycling cavity: enlarge detector bandwidth at high frequency

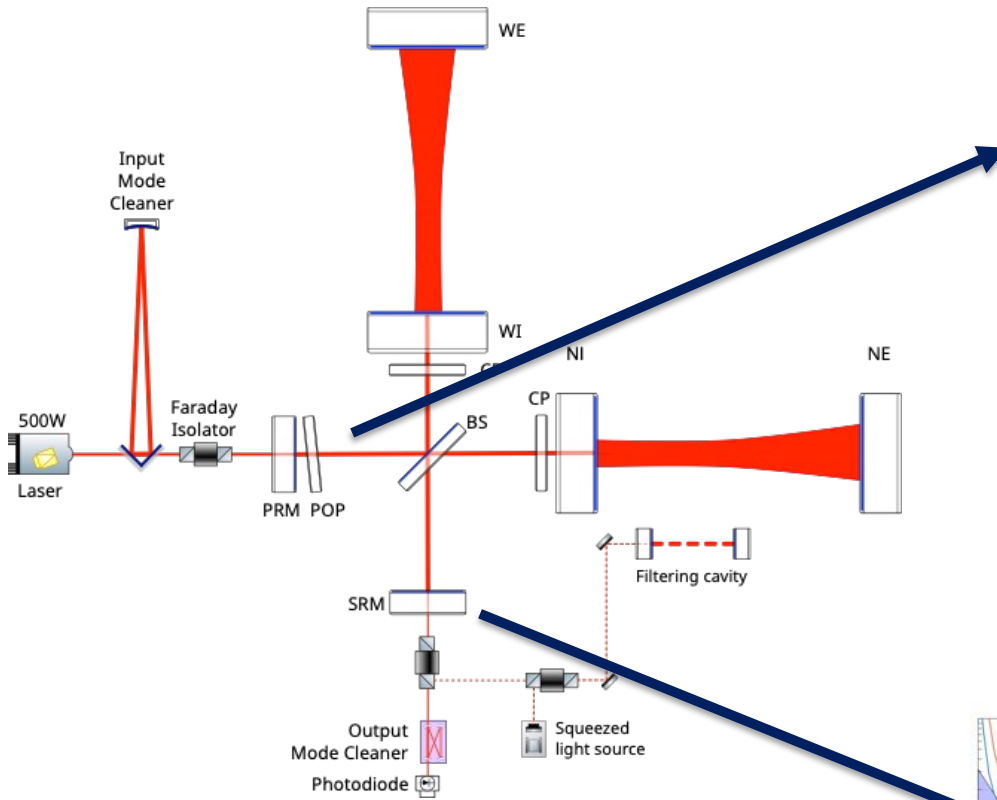
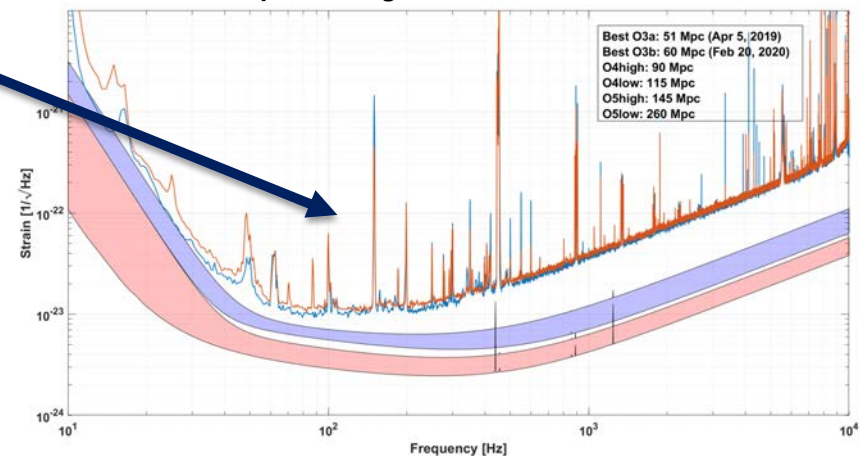

Gaussian beams

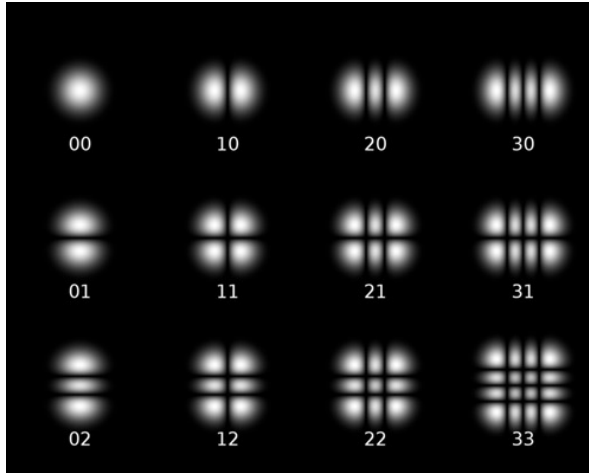

$$E(r, z) = \psi(r, z)e^{-ikz} = E_0 \frac{w_0}{w(z)} \exp\left(i\eta(z) - \frac{ikr^2}{2R(z)} - \frac{r^2}{w^2(z)} - ikz\right)$$

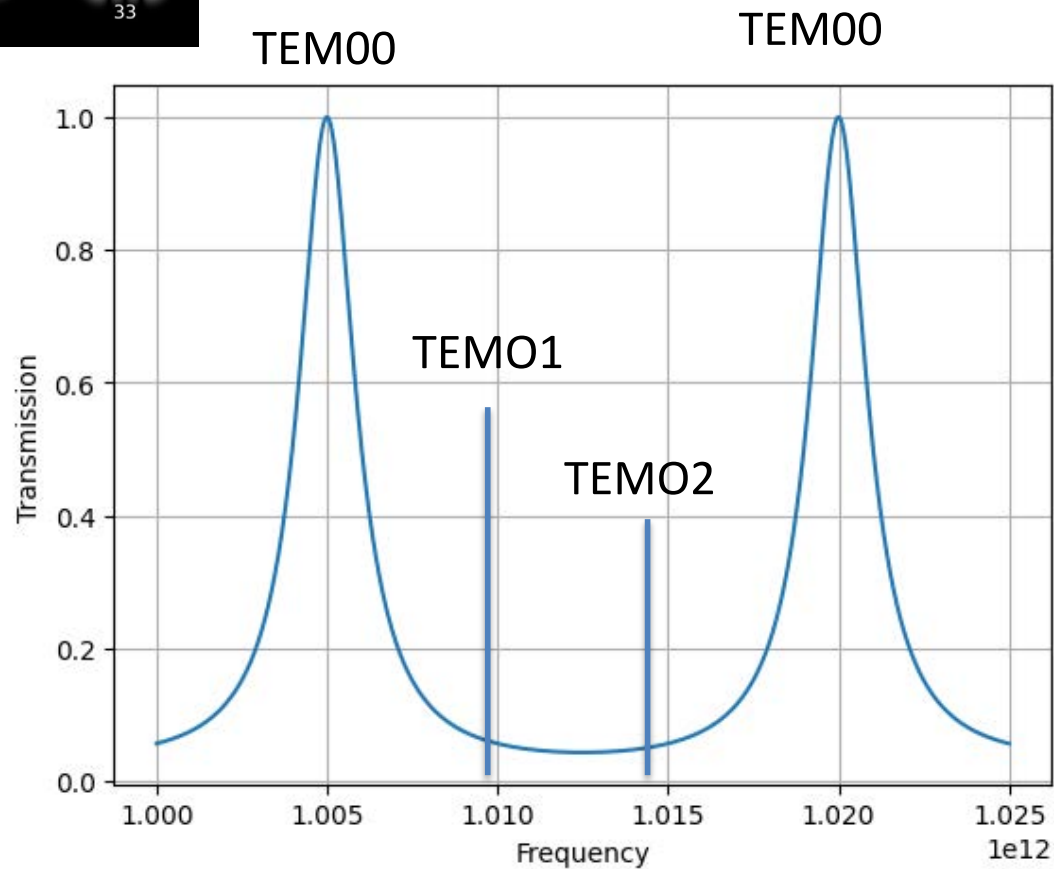

Stable vs marginally stable cavities

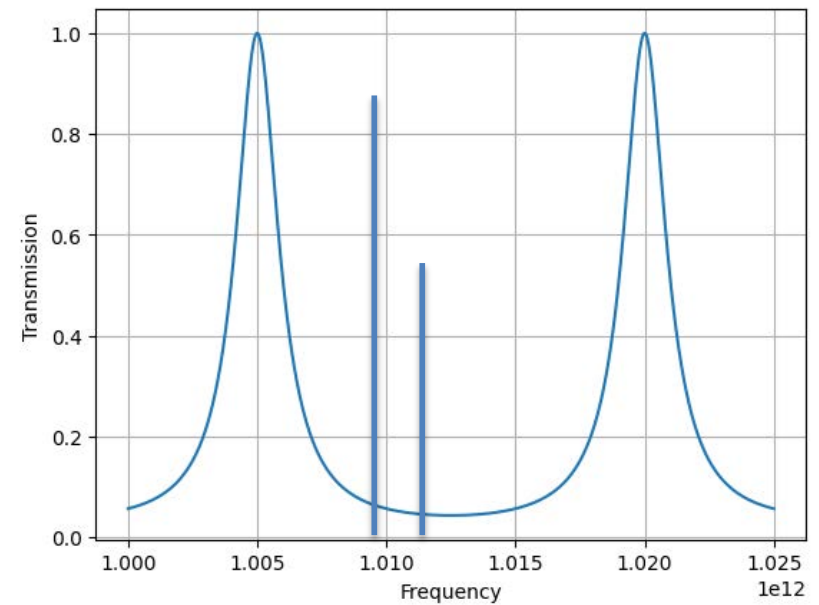
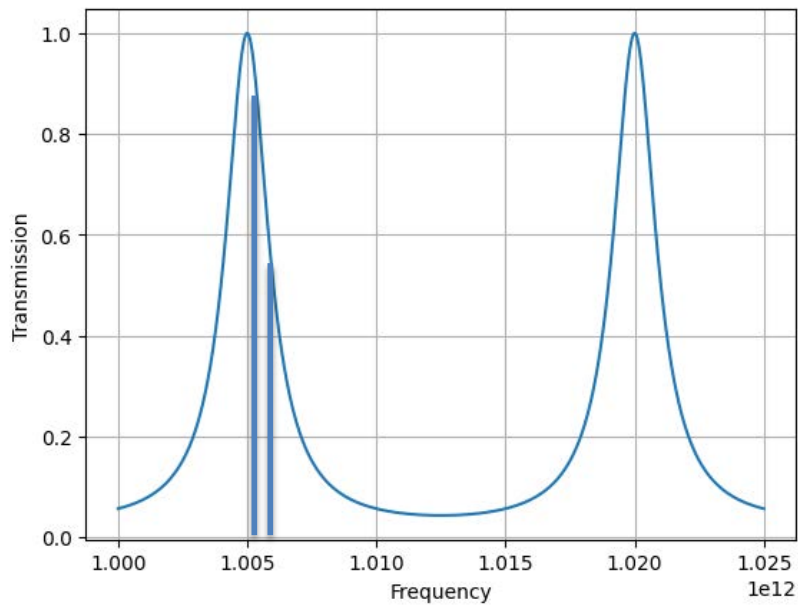
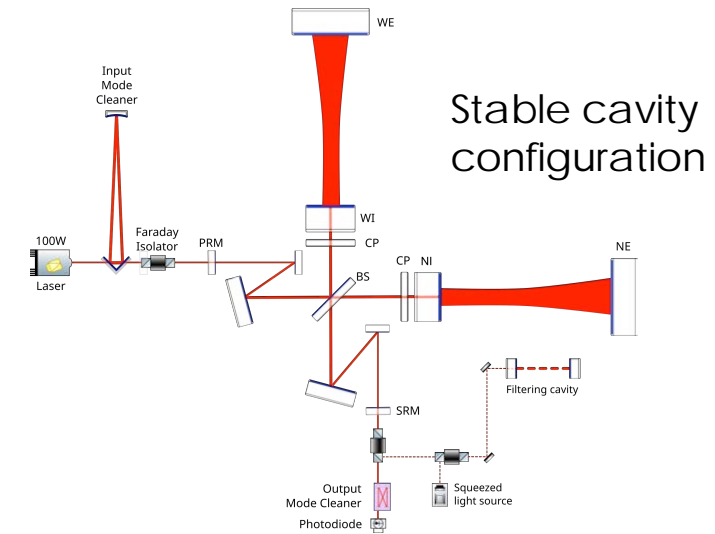
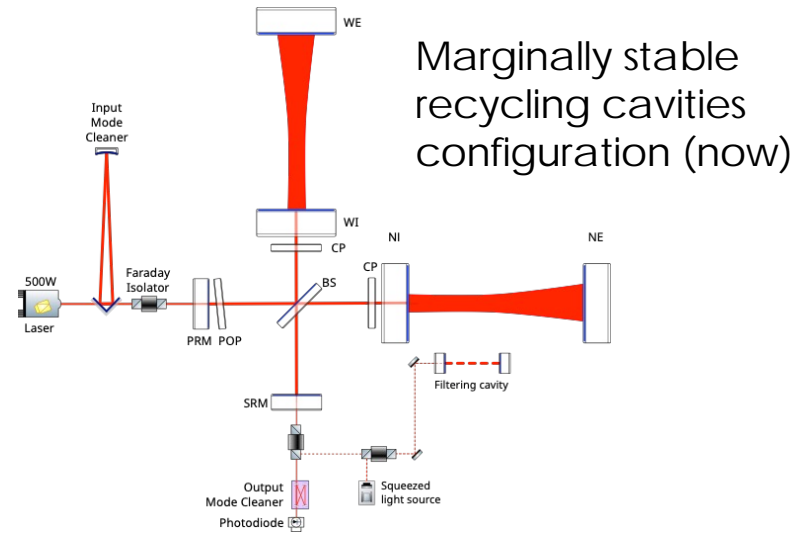

Problems with marginally stable cavities

- The high-order modes (HOMs) resonant in the recycling cavities create optical offsets on the error signals used to control the interferometer.
- The different degrees of freedom are more coupled, which increases the complexity of the controls
- The quantity of the HOMs changes during a thermal transient just after the lock of the interferometer
- The HOMs present on the output port of the detector are amplified in the signal recycling cavity, which degrade the contrast defect
- The losses due to the HOMs create optical losses and degrade the squeezing performances.
- The simulations are also more complex and less reliable

Why Virgo_nEXT

- 🧪 Continue Virgo's science programme in the LVK gravitational-wave detector network
- 🚀 Push the potential of the existing infrastructure to its limits
- 🔧 Test the technologies used in the ET avoiding design mistakes and accelerating commissioning
- 🕒 Fill a potential gap of a decade between the end of O5 and the first ET design sensitivity
- 👥 Keep and develop the expertise of the experimental and data analysis community
- ↔️ Ensure smooth generational transition and training of new leaders

Virgo_nEXT vs Einstein Telescope



ET-high-frequency: longer arms,
underground **with Virgo_nEXT technologies**

ET-low-frequency: cryogenic, low
frequency **technical noises similar to the
Virgo_nEXT ones**

See
Edwige's
presentation

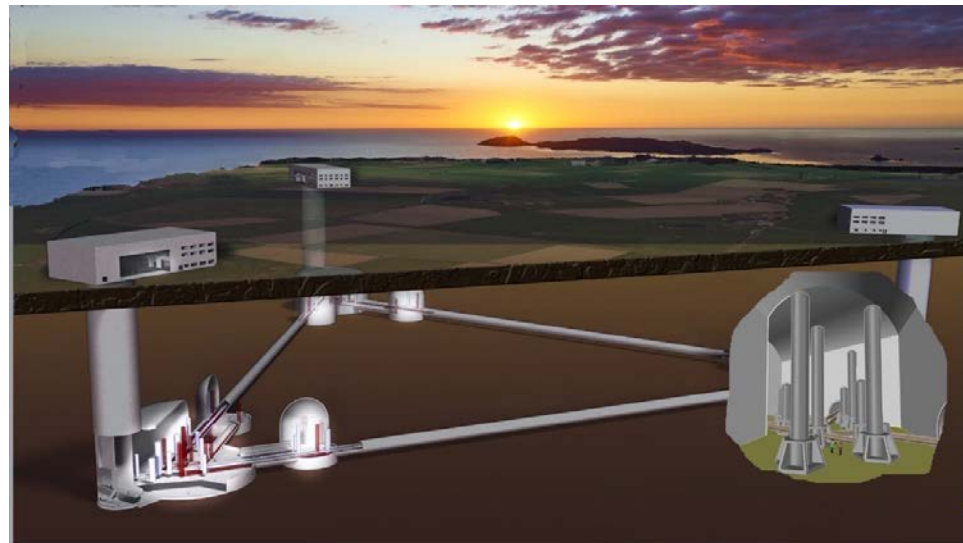

Why Virgo_nEXT

- ⚗ Continue Virgo's science programme in the LVK gravitational-wave detector network
- 🚀 Push the potential of the existing infrastructure to its limits
- 🔧 Test the technologies used in the ET avoiding design mistakes and accelerating commissioning
- 🕒 Fill a potential gap of a decade between the end of O5 and the first ET design sensitivity
- 👥 Keep and develop the expertise of the experimental and data analysis community
- ↔ Ensure smooth generational transition and training of new leaders

GW detectors and observing runs

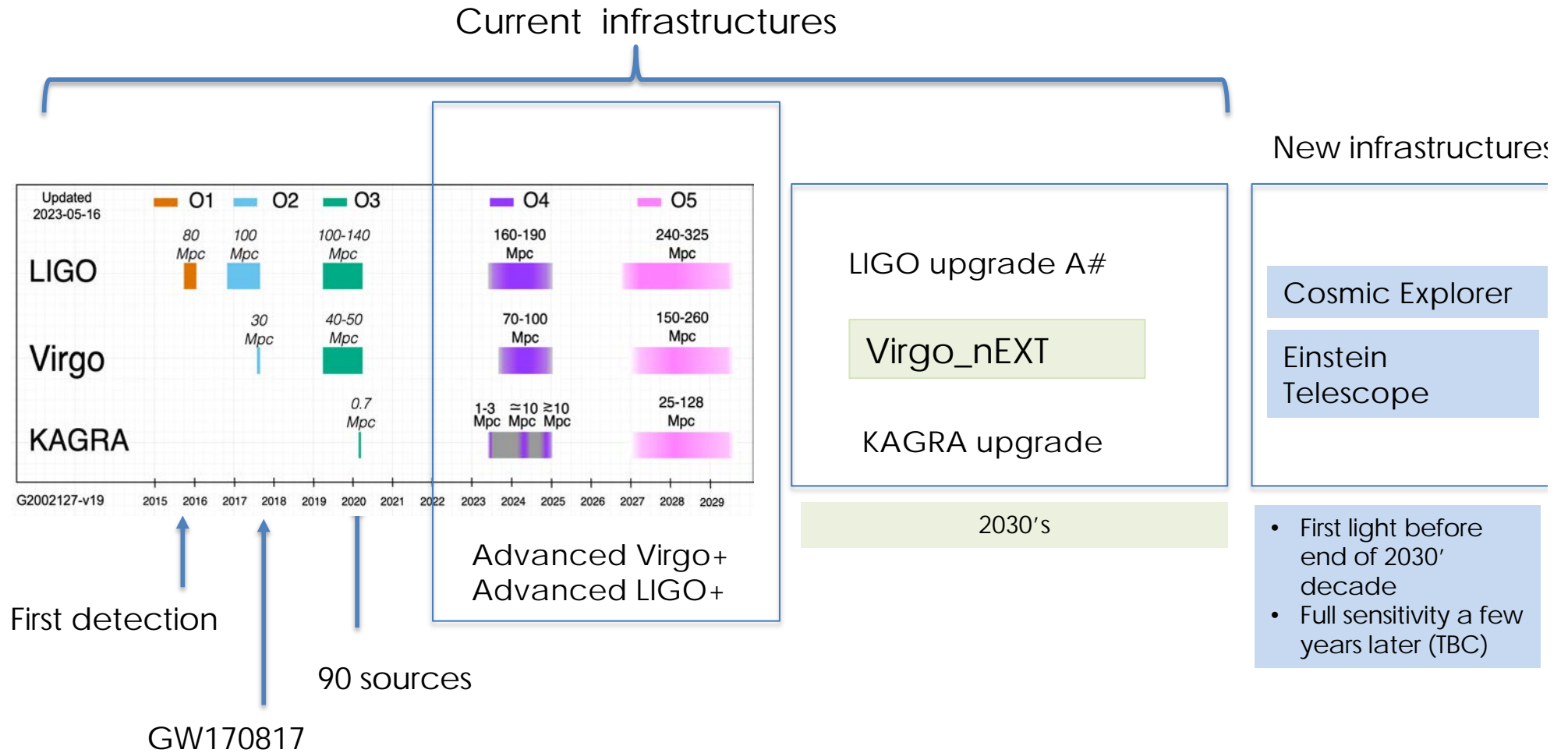

Extra slides

AdV+ sensitivity possible evolutions

